



Product Catalog

Air-Cooled Series R™ Chillers **Model RTAC** 140-500 Nominal Tons (60 Hz)





Introduction

Like its chillers, Trane wants its relationships with customers to last. Trane is interested in maintaining long term, loyal relationships. This perspective means the point in time that a customer purchases a chiller is the beginning of a relationship, not the end. Your business is important, but your satisfaction is paramount.

The RTAC offers high reliability coupled with proven Series R performance.

The Series R Model RTAC is an industrial grade design built for both the industrial and commercial markets. It is ideal for schools, hospitals, retailers, office buildings, Internet service providers and manufacturing facilities.

Trademarks

Trane and the Trane logo, Series R and Tracer Summit are trademarks of Trane in the United States and other countries. All trademarks referenced in this document are the trademarks of their respective owners.

Revision Summary

RLC-PRC006-EN (25 May 2012)

The following points describe the changes to this revision on the manual:

- Added new extra efficiency unit data
- Created a 60 Hz only version of the catalog
- Updated electrical connection drawings



Table of Contents

Features and Benefits	4
Application Considerations	7
Model Number Description	13
Performance Data	20
Controls	29
Electrical Data	32
Electrical Connection	50
Dimensions	58
Weights	68
Mechanical Specifications	69
Options	70



Features and Benefits

World Class Energy Efficiency

The importance of energy efficiency cannot be understated. Fortunately, ASHRAE has created a guideline emphasizing its importance. Nonetheless, energy is often dismissed as an operational cost over which the owner has little control. That perception results in missed opportunities for energy efficiency, reduced utility bills, and higher profits. Lower utility bills directly affect profitability. Every dollar saved in energy goes directly to the bottom line. Trane's RTAC is one way to maximize your profits.

ASHRAE Standard 90.1 and Executive Order

All Trane air-cooled chillers meet the new efficiency levels mandated by ASHRAE Standard 90.1. This new standard requires higher efficiencies than past technologies can deliver. The US Federal Government has adopted standard 90.1 and, in some cases, requires even higher efficiencies. Federal Executive Order mandates energy consuming devices procured must be in the top 25% of their class. In the case of chillers, that product standard is ASHRAE 90.1. Trane's RTAC meets and exceeds the efficiency requirements of 90.1, while the high and extra efficiency RTAC can meet the "stretch goals" of Executive Order.

Precise Capacity Control

Trane's patented unloading system allows the compressor to modulate infinitely and exactly match building loads. At the same time chilled water temperatures will be maintained within +/- 1/2°F (0.28°C) of setpoint. Screw or scroll chillers with stepped capacity control do well to maintain chilled water temperatures within 2°F (1.1°C) of setpoint. Stepped control also results in over cooling because rarely does the capacity of the machine match the building load. The result can be 10% higher energy bills. Trane's RTAC optimizes the part load performance of your machine for energy efficiency, precise control for process applications, and your personal comfort regardless of the weather outside.

Excellent Reliability

A buildings environment is expected to be comfortable. When it is, no one says a word. If it's not... that's a different story. The same is true with chillers. No one ever talks about chillers, yet alone compressors, until they fail, and tenants are uncomfortable and productivity is lost. Trane's helical rotary compressors have been designed and built to stay running when you need them.

Fewer moving parts

Trane's helical rotary compressors have only two major rotating parts: the male and female rotor. A reciprocating compressor can have more than 15 times that number of critical parts. Multiples of pistons, valves, crankshafts, and connecting rods in a reciprocating unit all represent different failure paths for the compressor. In fact, reciprocating compressors can easily have a failure rate four times of a helical rotor. Combine that with two to three reciprocating compressors for each helical rotary compressor on chillers of equal tonnage, and statistics tell you it's a matter of time before you lose a reciprocating compressor.

Robust components

Helical rotary compressors are precisely machined using state of the art processes from solid metal bar stock. Tolerances are maintained within a micron or less than a tenth of the diameter of a human hair. The resulting compressor is a robust yet highly sophisticated assembly capable of ingesting liquid refrigerant without risk of damage.

Condenser coils

Trane's condenser coils are manufactured with the same philosophy as the compressors; they're built to last. Even though manufacturing processes have allowed thinner and thinner materials in their assembly, with obvious material and manufacturing savings, Trane's coil material did not change with the RTAC generation of air cooled chillers. Substantial condenser fins, that do not require additional coating in non-corrosive environments, contribute to the highest reliability standards for air-cooled chillers in the industry.

Superior Control

The Adaptive Control™ microprocessor system enhances the air-cooled Series R chiller by providing the very latest chiller control technology. With the Adaptive Control microprocessor, unnecessary service calls and unhappy tenants are avoided. The unit is designed not to trip or unnecessarily shut down. Only when the Tracer™ chiller controllers have exhausted all possible corrective actions and the unit is still violating an operating limit will the chiller shut down. Controls on other equipment typically shut down the chiller, usually just when it is needed the most.

For example: A typical five year old chiller with dirty coils might trip out on high pressure cutout on a 100°F (38°C) day in August. A hot day is just when comfort cooling is needed the most. In contrast, the air-cooled Series R chiller with an Adaptive Control microprocessor will stage fans on, modulate electronic expansion valves, and modulate slide valve positions as the chiller approaches a high pressure cutout, thereby keeping the chiller online when you need it the most.

Simple Installation

- **Factory Installed Flow Switch.** Installed in the optimum location in the piping for reduced chiller installation cost and superior flow sensing, reducing the potential for nuisance trips.
- **Close Spacing Installation.** The air-cooled Series R™ Chiller has the tightest recommended side clearance in the industry, four feet for maximum performance. In situations where equipment must be installed with less clearance than recommended, which frequently occurs in retrofit applications, restricted airflow is common. Conventional chillers may not work at all. However, the air-cooled Series R chiller with Adaptive Control™ microprocessor will make as much chilled water as possible given the actual installed conditions, stay on line during unforeseen abnormal conditions, and optimize the unit performance. Consult your Trane sales engineer for more details.
- **Factory Testing Means Trouble Free Startup.** All air-cooled Series R chillers are given a complete functional test at the factory. This computer based test program completely checks the sensors, wiring, electrical components, microprocessor function, communication capability, expansion valve performance and fans. In addition, each compressor is run and tested to verify capacity and efficiency. Where applicable, each unit is factory preset to the customer's design conditions; an example would be leaving liquid temperature setpoint. The result of this test program is that the chiller arrives at the job site fully tested and ready for operation.
- **Factory Installed and Tested Controls/Options Speed Installation.** All Series R chiller options, including main power supply disconnect, low ambient control, ambient temperature sensor, low ambient lockout, communication interface and ice making controls, are factory installed and tested. Some manufacturers send accessories in pieces to be field installed. With Trane, the customer saves on installation expense and has assurance that ALL chiller controls/options have been tested and will function as intended.

Unit Performance Testing

The AHRI Certification Program has had a certification program covering air-cooled water chillers for many years. With this in mind, customers may ask, "Do I need to factory performance test my chiller?"

Trane began promoting factory performance tests for water-cooled water chillers in 1984 for the same reasons it is valid today for air-cooled water chillers, to show we stand behind the products we design and build.

The benefits of a performance test include verification of performance, prevention of operational problems, and assurance of a smooth startup. Only a performance test conducted in a laboratory or laboratory grade facility will confirm both performance and operation of a specific chiller.

While most factory performance tests go smoothly, should problems occur, Trane personnel can quickly correct them and the chiller will ship as specified. Job site diagnosis, ordering of parts, and waiting for delivery of replacement components is significantly reduced.

A factory performance test reduces startup time, thereby saving job site expense. A chiller that has been tested is operation and performance proven. This allows the installing contractor to concentrate on proper electrical wiring and water piping, and the service technicians to concentrate on proper refrigerant charge, safeties diagnosis and initial logging of the chiller. Means of obtaining full load on the chiller and proving its performance do not have to be determined by engineers or contractors, thus saving time. The certified test report documents performance for the unit as built. In addition, factory testing significantly reduces commissioning time and risk by reintroducing manufacturer responsibility, where its mitigation should reside.

When a factory performance test is requested, the test can be conducted at the specified design conditions for all packaged chillers from 70 to 500 tons. The test facility has the capability to control ambient test conditions to assure our customers that our chillers will perform as predicted.



Application Considerations

Important

Certain application constraints should be considered when sizing, selecting and installing Trane air-cooled Series R chillers. Unit and system reliability is often dependent upon proper and complete compliance with these considerations. When the application varies from the guidelines presented, it should be reviewed with your local Trane sales engineer.

Unit Sizing

Unit capacities are listed in the performance data section. Intentionally over sizing a unit to assure adequate capacity is not recommended. Erratic system operation and excessive compressor cycling are often a direct result of an oversized chiller. In addition, an oversized unit is usually more expensive to purchase, install, and operate. If over sizing is desired, consider using multiple units.

Water Treatment

Dirt, scale, products of corrosion and other foreign material will adversely affect heat transfer between the water and system components. Foreign matter in the chilled water system can also increase pressure drop and consequently, reduce water flow. Proper water treatment must be determined locally, depending on the type of system and local water characteristics. Neither salt nor brackish water is recommended for use in Trane air-cooled Series R chillers. Use of either will lead to a shortened life to an indeterminable degree. The Trane Company encourages the employment of a reputable water treatment specialist, familiar with local water conditions, to assist in this determination and in the establishment of a proper water treatment program.

Effect Of Altitude On Capacity

Air-cooled Series R chiller capacities given in the performance data tables are for use at sea level. At elevations substantially above sea level, the decreased air density will reduce condenser capacity and, therefore, unit capacity and efficiency.

Ambient Limitations

Trane air-cooled Series R chillers are designed for year round operation over a range of ambient temperatures. The Model RTAC chiller will operate as standard in ambient temperatures of 25°F to 115°F (-4°C to 46°C). With the low ambient option, these units will operate down to 0°F (-18°C). If an ambient temperature as high as 125°F (51°C) is the basis for design, the high ambient option will permit the chiller to run without going into a limiting condition. For installations in areas with large ambient differences, the wide ambient option will allow the chiller to perform uninhibited from 0°F to 125°F (-18°C to 51°C).

Water Flow Limits

The minimum and maximum water flow rates are given in the General Data tables. Evaporator flow rates below the tabulated values will result in laminar flow causing freeze up problems, scaling, stratification and poor control. Flow rates exceeding those listed may result in excessive tube erosion.

Leaving Water Temperature Limits

Trane air-cooled Series R chillers have three distinct leaving water categories: standard, low temperature, and ice making. The standard leaving solution temperature range is 40 to 60°F (4.4 to 15.6°C). Low temperature machines produce leaving liquid temperatures less than 40°F (4.4°C). Since liquid supply temperature setpoints less than 40°F (4.4°C) result in suction temperatures at or below the freezing point of water, a glycol solution is required for all low temperature machines. Ice making machines have a leaving liquid temperature range of 20 to 60°F (-6.7 to 15.6°C). Ice making controls include dual setpoint controls and safeties for ice making and standard cooling capabilities. Consult your local Trane sales engineer for applications or selections involving low temperature or ice making machines. The maximum water temperature that can be circulated through an evaporator when the unit is not operating is 108°F (42°C).

Application Considerations

Flow Rates Out of Range

Many process cooling jobs require flow rates that cannot be met with the minimum and maximum published values for the Model RTAC evaporator. A simple piping change can alleviate this problem. For example: A plastic injection molding process requires 80 gpm (5.1 l/s) of 50°F (10°C) water and returns that water at 60°F (15.6°C). The selected chiller can operate at these temperatures, but has a minimum flow rate of 120 gpm (7.6 l/s). The system layout in Figure A1 can satisfy the process.

Figure 1. Flow rate out of range system layout

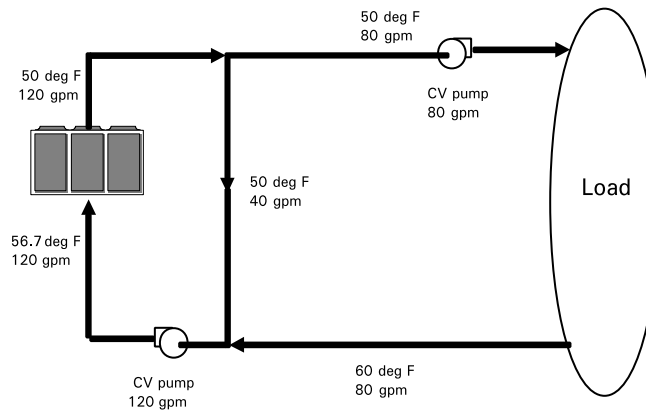

Flow Control

Trane requires the chilled water flow control in conjunction with the Air-Cooled Series R Chiller to be done by the chiller. This will allow the chiller to protect itself in potentially harmful conditions.

Supply Water Temperature Drop

The performance data for the Trane air-cooled Series R chiller is based on a chilled water temperature drop of 10°F (5.6°C). Chilled water temperature drops from 6 to 18°F (3.3 to 10°C) may be used as long as minimum and maximum water temperatures and flow rates are not violated. Temperature drops outside this range are beyond the optimum range for control and may adversely affect the microcomputer's ability to maintain an acceptable supply water temperature range. Further, temperature drops of less than 6°F (3.3°C) may result in inadequate refrigerant superheat. Sufficient superheat is always a primary concern in any refrigerant system and is especially important in a package chiller where the evaporator is closely coupled to the compressor. When temperature drops are less than 6°F (3.3°C), an evaporator runaround loop may be required.

Leaving Water Temperature Out of Range

Many process cooling jobs require temperature ranges that cannot be met with the minimum and maximum published values for the Model RTAC evaporator. A simple piping change can alleviate this problem. For example: A laboratory load requires 120 gpm (7.6 l/s) of water entering the process at 85°F (29.4°C) and returning at 95°F (35°C). The accuracy required is better than the cooling tower can give. The selected chiller has adequate capacity, but a maximum leaving chilled water temperature of 60°F (15.6°C).

In Figure A2, both the chiller and process flow rates are equal. This is not necessary. For example, if the chiller had a higher flow rate, there would simply be more water bypassing and mixing with warm water.

Figure 2. Temperature out of range system layout

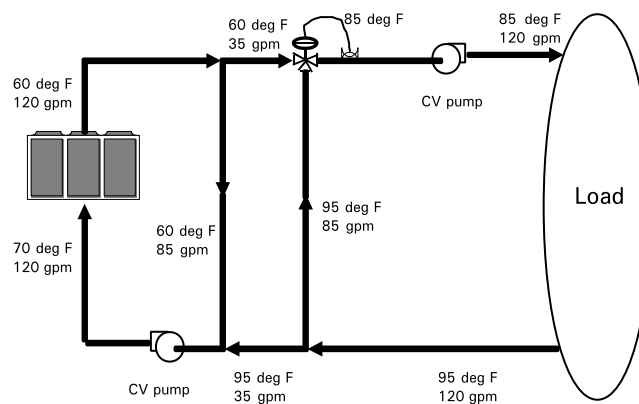

Variable Flow in the Evaporator

An attractive chilled water system option may be a variable primary flow (VPF) system. VPF systems present building owners with several cost saving benefits that are directly related to the pumps. The most obvious cost savings result from eliminating the secondary distribution pump, which in turn avoids the expense incurred with the associated piping connections (material, labor), electrical service, and variable frequency drive. Building owners often cite pump related energy savings as the reason that prompted them to install a VPF system.

The evaporator on the Model RTAC can withstand up to 50 percent water flow reduction as long as this flow is equal to or above the minimum flow rate requirements. The microprocessor and capacity control algorithms are designed to handle a maximum of 10% change in water flow rate per minute in order to maintain $\pm 0.5^\circ\text{F}$ (0.28°C) leaving evaporator temperature control. For applications in which system energy savings is most important and tight temperature control is classified as $\pm 2^\circ\text{F}$ (1.1°C), up to 30 percent changes in flow per minute are possible.

With the help of a software analysis tool such as System Analyzer™, DOE-2 or TRACE™, you can determine whether the anticipated energy savings justify the use of variable primary flow in a particular application. It may also be easier to apply variable primary flow in an existing chilled water plant. Unlike the "decoupled" system design, the bypass can be positioned at various points in the chilled water loop and an additional pump is unnecessary.

Application Considerations

Series Chiller Arrangements

Another energy saving strategy is to design the system around chillers arranged in series. The actual savings possible with such strategies depends on the application dynamics and should be researched by consulting your Trane Systems Solutions Representative and applying an analysis tool from the Trace software family. It is possible to operate a pair of chillers more efficiently in a series chiller arrangement than in a parallel arrangement. It is also possible to achieve higher entering to leaving chiller differentials, which may, in turn, provide the opportunity for lower chilled water design temperature, lower design flow, and resulting installation and operational cost savings. The Trane screw compressor also has excellent capabilities for "lift," which affords an opportunity for "lift," which affords an opportunity for savings on the evaporator water loop.

Series chiller arrangements can be controlled in several ways. Figure A3 shows a strategy where each chiller is trying to achieve the system design set point. If the cooling load is less than 50 percent of the systems capabilities, either chiller can fulfill the demand. As system loads increase, the Chiller 2 becomes preferentially loaded as it attempts to meet the leaving chilled water setpoint. Chiller 1 will finish cooling the leaving water from Chiller 2 down to the system design setpoint.

Staggering the chiller set points is another control technique that works well for preferentially loading Chiller 1. If the cooling load is less than 50 percent of the system capacity, Chiller 1 would be able to satisfy the entire call for cooling. As system loads increase, Chiller 2 is started to meet any portion of the load that Chiller 1 can not meet.

Figure 3. Typical series chiller arrangement

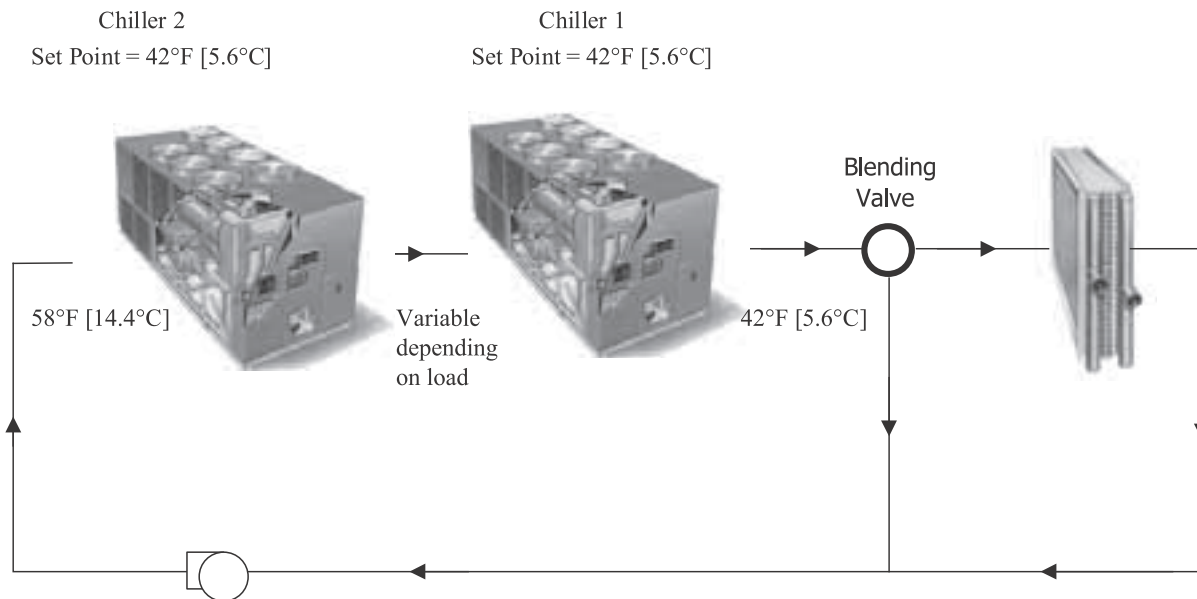

Typical Water Piping

All building water piping must be flushed prior to making the final connections to the chiller. To reduce heat loss and prevent condensation, insulation should be installed. Expansion tanks are also usually required so that chilled water volume changes can be accommodated.

Short Water Loops

The proper location of the temperature control sensor is in the supply (outlet) water connection or pipe. This location allows the building to act as a buffer and assures a slowly changing return water temperature. If there is not a sufficient volume of water in the system to provide an adequate buffer, temperature control can be lost, resulting in erratic system operation and excessive compressor cycling. A short water loop has the same effect as attempting to control from the building return water. Typically, a two minute water loop is sufficient to prevent problems. Therefore, as a guideline, ensure the volume of water in the evaporator loop equals or exceeds two times the evaporator flow rate in gallons per minute. For a rapidly changing load profile, the amount of volume should be increased. To prevent the effect of a short water loop, the following items should be given careful consideration: A storage tank or larger header pipe to increase the volume of water in the system and, therefore, reduce the rate of change of the return water temperature.

Applications Types

- Comfort cooling.
- Industrial process cooling.
- Ice/thermal storage.
- Low temperature process cooling.

Typical Unit Installation

Outdoor HVAC equipment must be located to minimize noise and vibration transmission to the occupied spaces of the building structure it serves. If the equipment must be located in close proximity to a building, it could be placed next to an unoccupied space such as a storage room, mechanical room, etc. It is not recommended to locate the equipment near occupied, sound sensitive areas of the building or near windows. Locating the equipment away from structures will also prevent sound reflection, which can increase levels at property lines, or other sensitive points.

When physically isolating the unit from structures, it is a good idea to not use rigid supports, and to eliminate any metal-to-metal or hard material contact, when possible. This includes replacing spring or metal weave isolation with elastomeric isolators. Figure A4 illustrates isolation recommendations for the RTAC.

For chiller sound ratings, installation tips and considerations on chiller location, pipe isolation, etc., refer to the Trane Air-Cooled Series R Chillers Sound Data and Application Guide for Noise Sensitive Installations.

System Options - Ice Storage

Trane air-cooled Series R Chillers are well suited for ice production. An air-cooled machine typically switches to ice production at night. Two things happen under this assumption. First, the leaving brine temperature from the evaporator is lowered to around 22 to 24°F (-5.5 to -4.4°C). Second, the ambient temperature has typically dropped about 15 to 20°F (8.3 to 11°C) from the peak daytime ambient. This effectively places a lift on the compressors that is similar to daytime running conditions. The chiller can operate in lower ambient at night and successfully produce ice to supplement the next day's cooling demands.

The Model RTAC produces ice by supplying ice storage tanks with a constant supply of glycol solution. Air-cooled chillers selected for these lower leaving fluid temperatures are also selected for efficient production of chilled fluid at nominal comfort cooling conditions. The ability of Trane chillers to serve "double duty" in ice production and comfort cooling greatly reduces the capital cost of ice storage systems.



Application Considerations

When cooling is required, ice chilled glycol is pumped from the ice storage tanks directly to the cooling coils. No expensive heat exchanger is required. The glycol loop is a sealed system, eliminating expensive annual chemical treatment costs. The air-cooled chiller is also available for comfort cooling duty at nominal cooling conditions and efficiencies. The modular concept of glycol ice storage systems and the proven simplicity of Trane Tracer controllers allow the successful blend of reliability and energy saving performance in any ice storage application.

The ice storage system is operated in six different modes: each optimized for the utility cost of the hour.

1. Provide comfort cooling with chiller
2. Provide comfort cooling with ice
3. Provide comfort cooling with ice and chiller
4. Freeze ice storage
5. Freeze ice storage when comfort cooling is required
6. Off

Tracer optimization software controls operation of the required equipment and accessories to easily transition from one mode of operation to another. For example:

Even with ice storage systems there are numerous hours when ice is neither produced or consumed, but saved. In this mode the chiller is the sole source of cooling. For example, to cool the building after all ice is produced but before high electrical demand charges take effect, Tracer sets the air-cooled chiller leaving fluid setpoint to its most efficient setting and starts the chiller, chiller pump, and load pump.

When electrical demand is high, the ice pump is started and the chiller is either demand limited or shut down completely. Tracer controls have the intelligence to optimally balance the contribution of ice and chiller in meeting the cooling load.

The capacity of the chiller plant is extended by operating the chiller and ice in tandem. Tracer rations the ice, augmenting chiller capacity while reducing cooling costs. When ice is produced, Tracer will lower the air-cooled chiller leaving fluid setpoint and start the chiller, ice and chiller pumps, and other accessories. Any incidental loads that persist while producing ice can be addressed by starting the load pump and drawing spent cooling fluid from the ice storage tanks.

For specific information on ice storage applications, contact your local Trane sales office.

Model Number Description

Digits 1, 2 - Unit model

RT = Rotary chiller

Digit 3 - Unit type

A = Air-cooled

Digit 4 - Development sequence

C = Development sequence

Digit 5, 6 & 7 - Nominal capacity

140 = 140 Nominal tons
 155 = 155 Nominal tons
 170 = 170 Nominal tons
 185 = 185 Nominal tons
 200 = 200 Nominal tons
 225 = 225 Nominal tons
 250 = 250 Nominal tons
 275 = 275 Nominal tons
 300 = 300 Nominal tons
 350 = 350 Nominal tons
 400 = 400 Nominal tons
 450 = 450 Nominal tons
 500 = 500 Nominal tons

Digit 8 - Unit voltage

A = 200/60/3
 C = 230/60/3
 J = 380/60/3
 4 = 460/60/3
 5 = 575/60/3

Digit 9 - Manufacturing location

U = Water Chiller Business Unit,
 Pueblo, CO USA

Digit 10, 11 - Design sequence

XX = Factory Input

Digit 12 - Unit basic configuration

N = Standard efficiency/performance configuration
 H = High efficiency/performance configuration
 A = Extra efficiency/performance configuration

Digit 13 - Agency listing

N = No agency listing
 U = UL/CUL listing

Digit 14 - Pressure vessel code

A = ASME pressure vessel code
 C = Canadian code
 D = Australian code
 L = Chinese code

Digit 15 - Evaporator application

F = Standard (40-60 F) leaving temp
 G = Low (Less than 40 F) leaving temp
 R = Remote (40-60 F) leaving temp

Digit 16 - Evaporator configuration

N = 2 pass arrangement, 0.75" insulation
 P = 3 pass arrangement, 0.75" insulation
 Q = 2 pass arrangement, 1.25" insulation
 R = 3 pass arrangement, 1.25" insulation

Digit 17 - Condenser application

N = Standard ambient range (25-115 F)
 H = High ambient capability (25-125 F)
 L = Low ambient capability (0-115 F)
 W = Wide ambient capability (0-125 F)

Digit 18 - Condenser fin material

1 = Standard aluminum slit fins
 2 = Copper fins
 4 = CompleteCoat epoxy coated fins

Digit 19 - Condenser fan/motor configuration

T = STD fans with TEAO motors
 W = Low noise fans

Digit 20 - Compressor motor starter type

X = Across-the-line starter
 Y = Wye-delta closed transition starter

Digit 21 - Incoming power line connection

1 = Single point power connection
 2 = Dual point power connection

Digit 22 - Power line connection type

T = Terminal block connection for incoming line(s)
 D = Non-fused disconnect switch(es) for incoming line(s)
 C = Circuit breaker(s) for incoming line(s)

Digit 23 - Unit operator interface

D = DynaView operator interface

Digit 24 - Remote operator interface

N = No remote interface
 C = Tracer Comm 3 interface
 B = BACnet interface
 L = LonTalk compatible (LCI-C) interface

Digit 25 - Control input accessories/options

N = No remote inputs
 R = Ext. evaporator leaving water setpoint
 C = Ext. current limit setpoint
 B = Ext. leaving water and current limit setpoint

Digit 26 - Control output accessories/options

N = No output options
 A = Alarm relay outputs
 C = Ice making I/O
 D = Alarm relay outputs and ice making I/O

Digit 27 - Electrical protection options

0 = No short circuit rating
 5 = Default short circuit rating
 6 = High amp short circuit rating

Digit 28 - Flow Switch

T = Factory installed flow switch - water
 U = Factory installed flow switch - glycol

Digit 29 - Control panel accessories

N = No convenience outlet
 A = 15A 115V convenience outlet (60Hz)

Digit 30 - Service valves

1 = With suction service valves

Digit 31 - Compressor sound attenuation option

0 = No compressor sound attenuation
 1 = Factory installed compressor sound attenuation

Digit 32 - Appearance options

N = No appearance options
 A = Architectural louvered panels
 C = Half louvers

Digit 33 - Installation accessories

N = No installation accessories
 R = Neoprene in shear unit isolators
 F = Flange kit for water connections
 G = Neoprene isolators and flange kit

Digit 34 - Factory testing options

0 = Standard functional test
 C = Customer-witnessed performance test with report
 E = Non-witnessed performance test with report



General Data

Table 1. 60 Hz standard efficiency – I-P

Size		140	155	170	185	200	225	250	275	300	350	400	450	500
Compressor		Screw												
Quantity	#	2	2	2	2	2	2	2	3	3	3	4	4	4
Nominal size @60Hz	(tons)	70/70	85/70	85/85	100/85	100/100	120/100	120/120	85-85/100	100-100/100	120-120/100	100-100/100-100	120-120/100-100	120-120/120-120
Evaporator		Flooded												
Water storage	(gal)	29	32	34	36	40	39	43	62	67	72	83	86	91
2 pass arrangement														
Min flow	(gpm)	193	214	202	217	241	217	241	309	339	375	404	422	461
Max flow	(gpm)	709	785	741	796	883	796	883	1134	1243	1374	1483	1548	1690
Water connection	(NPS-in)	4	4	6	6	6	6	6	8	8	8	8	8	8
3 pass arrangement														
Min flow	(gpm)	129	143	135	145	161	145	161	206	226	250	270	282	307
Max flow	(gpm)	473	523	494	531	589	531	589	756	829	916	989	1032	1127
Water connection	(NPS-in)	3.5	3.5	4	4	4	4	4	6	6	6	8	8	8
Condenser		Fin and tube												
Qty of coils	#	4	4	4	4	4	4	4	8	8	8	8	8	8
Coil length	(in)	156/156	180/156	180/180	216/180	216/216	252/216	252/252	180/108	216/108	252/108	216/216	252/216	252/252
Coil height	(in)	42	42	42	42	42	42	42	42	42	42	42	42	42
	(mm)	1067	1067	1067	1067	1067	1067	1067	1067	1067	1067	1067	1067	1067
# of rows	#	3	3	3	3	3	3	3	3	3	3	3	3	3
Fins per foot	(fpf)	192	192	192	192	192	192	192	192	192	192	192	192	192
Fan		Direct drive propeller												
Quantity	#	4/4	5/4	5/5	6/5	6/6	7/6	7/7	10/6	12/6	14/6	12/12	14/12	14/14
Diameter	(in)	30.0	30.0	30.0	30.0	30.0	30.0	30.0	30.0	30.0	30.0	30.0	30.0	30.0
Air flow per fan	(cfm)	9625	9394	9209	9209	9209	9210	9210	9209	9209	9208	9209	9210	9214
Power/motor	(hp)	1.5	1.5	1.5	1.5	1.5	1.5	1.5	1.5	1.5	1.5	1.5	1.5	1.5
Fan speed	(rpm)	1140	1140	1140	1140	1140	1140	1140	1140	1140	1140	1140	1140	1140
Tip speed	(Ft/min)	8954	8954	8954	8954	8954	8954	8954	8954	8954	8954	8954	8954	8954
General Unit		HFC-134a												
# Refrig ckts	#	2	2	2	2	2	2	2	2	2	2	2	2	2
% min load	%	15	15	15	15	15	15	15	15	15	15	15	15	15
Refrigerant charge	(lb)	165/165	175/165	175/175	215/210	215/215	225/215	225/225	365/200	415/200	460/200	415/415	460/415	460/460
Oil charge	(gal)	1.3/1.3	1.3/1.3	1.3/1.3	1.9/1.3	1.9/1.9	1.9/1.9	1.9/1.9	4.2/1.9	4.6/2.9	4.6/1.9	4.6/4.6	4.6/4.6	4.6/4.6
Min ambient-std	(°F)	25	25	25	25	25	25	25	25	25	25	25	25	25
Min ambient-low	(°F)	0	0	0	0	0	0	0	0	0	0	0	0	0

1. Data containing information on two circuits is shown as follows: ckt 1/ ckt 2.
 2. Minimum start-up/operating ambient is based on a 5 mph wind across the condenser.

Table 2. 60 Hz high efficiency – I-P

Size		140	155	170	185	200	225	250	275	300	350	400
Compressor		Screw										
Quantity	#	2	2	2	2	2	2	2	3	3	4	4
Nominal size @60Hz	(tons)	70/70	85/70	85/85	100/85	100/100	120/100	120/120	85-85/100	100-100/100	85-85/85/85	100-100/100-100
Evaporator		Flooded										
Water storage	(gal)	34	36	40	39	43	43	43	72	72	83	91
2 pass arrangement												
Min flow	(gpm)	202	217	241	217	241	241	241	375	375	404	461
Max flow	(gpm)	741	796	883	796	883	883	883	1374	1374	1483	1690
Water connection	(NPS-in)	6	6	6	6	6	6	6	8	8	8	8
3 pass arrangement												
Min flow	(gpm)	135	145	161	145	161	161	161	250	250	270	307
Max flow	(gpm)	494	531	589	531	589	589	589	916	916	989	1127
Water connection	(NPS-in)	4	4	4	4	4	4	4	6	6	8	8
Condenser		Fin and tube										
Qty of coils	#	4	4	4	4	4	8	8	8	8	8	8
Coil length	(in)	180/180	216/180	216/216	252/216	252/252	144/144	144/144	216/144	252/144	216/216	252/252
Coil height	(in)	42	42	42	42	42	42	42	42	42	42	42
Number of rows	#	192	192	192	192	192	192	192	192	192	192	192
Fins per foot	(fpf)	3	3	3	3	3	3	3	3	3	3	3
Fan		Direct drive propeller										
Quantity	#	5/5	6/5	6/6	7/6	7/7	8/6	8/8	12/6	14/6	12/12	14/14
Diameter	(in)	30	30	30	30	30	30	30	30	30	30	30
Air flow/fan	(cfm)	9199	9199	9199	9200	9201	9783	9203	9652	9605	9199	9201
Power/motor	(hp)	1.5	1.5	1.5	1.5	1.5	1.5	1.5	1.5	1.5	1.5	1.5
Fan speed	(rpm)	1140	1140	1140	1140	1140	1140	1140	1140	1140	1140	1140
Tip speed	(Ft/Min)	8954	8954	8954	8954	8954	8954	8954	8954	8954	8954	8954
General Unit		HFC-134a										
# Refrig ckts	#	2	2	2	2	2	2	2	2	2	2	2
% min load	%	15	15	15	15	15	15	15	15	15	15	15
Refrigerant charge	(lb)	175/175	215/205	215/215	225/215	225/225	235/235	235/235	415/200	460/200	415/415	460/460
Oil charge	(gal)	1.3/1.3	1.3/1.3	1.3/1.3	1.9/1.3	1.9/1.9	1.9/1.9	1.9/1.9	2.1-2.1/1.9	2.3-2.3/1.9	2.1-2.1/2.1-2.1	2.3-2.3/2.3-2.3
Min ambient-std	(°F)	25	25	25	25	25	25	25	25	25	25	25
Min ambient-low	(°F)	0	0	0	0	0	0	0	0	0	0	0

1. Data containing information on two circuits is shown as follows: ckt 1/ ckt 2.
 2. Minimum start-up/operating ambient is based on a 5 mph wind across the condenser.



Table 3. 60 Hz extra efficiency – I-P

Size		140	155	170	185	200	250	275	300	350
Compressor		Screw								
Quantity	#	2	2	2	2	2	3	3	4	4
Nominal size @60Hz	(tons)	70/70	85/70	85/85	100/85	100/100	70-70/85	85-85/85	70-70/70-70	85-85/85-85
Evaporator		Flooded								
Water storage	(gal)	40	39	43	43	43	72	72	83	91
2 pass arrangement										
Min flow	(gpm)	241	217	241	241	241	375	375	404	461
Max flow	(gpm)	883	796	883	883	883	1374	1374	1483	1690
Water connection	(NPS-in)	6	6	6	6	6	8	8	8	8
3 pass arrangement										
Min flow	(gpm)	161	145	161	161	161	250	250	270	307
Max flow	(gpm)	589	531	589	589	589	916	916	989	1127
Water connection	(NPS-in)	4	4	4	4	4	6	6	8	8
Condenser		Fin and tube								
Qty of coils	#	4	4	4	8	8	8	8	8	8
Coil length	(in)	216/216	252/216	252/252	144/144	180/180	216/144	252/144	216/216	252/252
Coil height	(in)	42	42	42	42	42	42	42	42	42
Number of rows	#	192	192	192	192	192	192	192	192	192
Fins per foot	(fpf)	3	3	3	3	3	3	3	3	3
Fan		Direct drive propeller								
Quantity	#	6/6	7/6	7/7	8/6	8/8	12/6	14/6	12/12	14/14
Diameter	(in)	30	30	30	30	30	30	30	30	30
Air flow/fan	(cfm)	9199	9200	9201	9783	9203	9652	9605	9199	9201
Power/motor	(hp)	1.5	1.5	1.5	1.5	1.5	1.5	1.5	1.5	1.5
Fan speed	(rpm)	1140	1140	1140	1140	1140	1140	1140	1140	1140
Tip speed	(Ft/Min)	8954	8954	8954	8954	8954	8954	8954	8954	8954
General Unit		HFC-134a								
# Refrig ckts	#	2	2	2	2	2	2	2	2	2
% min load	%	15	15	15	15	15	15	15	15	15
Refrigerant charge	(lb)	215/215	225/215	225/225	235/235	235/235	415/200	460/200	415/415	460/460
Oil charge	(gal)	1.3/1.3	1.9/1.3	1.9/1.9	1.9/1.9	1.9/1.9	2.1-2.1/1.9	2.1-2.1/1.9	2.1-2.1/2.1-2.1	2.1-2.1/2.1-2.1
Min ambient-std	(°F)	25	25	25	25	25	25	25	25	25
Min ambient-low	(°F)	0	0	0	0	0	0	0	0	0

1. Data containing information on two circuits is shown as follows: ckt 1/ ckt 2.
 2. Minimum start-up/operating ambient is based on a 5 mph wind across the condenser.

Table 4. 60 Hz standard efficiency – SI

Size		140	155	170	185	200	225	250	275	300	350	400	450	500
Compressor		Screw												
Quantity	#	2	2	2	2	2	2	2	3	3	4	4	4	4
Nominal size (tons) @60Hz		70/70	85/70	85/85	100/85	100/100	120/100	120/120	85-85/100	100-100/100	120-120/100	100-100/100-100	120-120/100-100	120-120/120-120
Evaporator		Flooded												
Water storage	(L)	110.0	121	129	136	151	148	163	235	254	273	314	326	344
2 pass arrangement														
Min flow	(L/s)	12	14	13	14	15	14	15	19	21	24	25	27	29
Max flow	(L/s)	45	50	47	50	56	50	56	72	78	87	94	98	107
Water connection	(NPS-in)	4	4	6	6	6	6	6	8	8	8	8	8	8
3 pass arrangement														
Min flow	(L/s)	8	9	9	9	10	9	10	13	14	16	17	18	19
Max flow	(L/s)	30	33	31	34	37	34	37	48	52	58	62	65	71
Water connection	(NPS-in)	3.5	3.5	4	4	4	4	4	6	6	6	8	8	8
Condenser		Fin and tube												
Qty of coils	#	4	4	4	4	4	4	4	8	8	8	8	8	8
Coil length	(mm)	3962/3962	4572/3962	4572/4572	5486/4572	5486/5486	6400/5486	6400/6400	4572/2743	5486/2743	6400/2743	5486/5486	6400/5486	6400/6400
Coil height	(mm)	1067	1067	1067	1067	1067	1067	1067	1067	1067	1067	1067	1067	1067
# of rows	#	3	3	3	3	3	3	3	3	3	3	3	3	3
Fins per foot	(fpf)	192	192	192	192	192	192	192	192	192	192	192	192	192
Fan		Direct drive propeller												
Quantity	#	4/4	5/4	5/5	6/5	6/6	7/6	7/7	10/6	12/6	14/6	12/12	14/12	14/14
Diameter	(mm)	726.0	726.0	726.0	726.0	726.0	726.0	726.0	726.0	726.0	726.0	726.0	726.0	726.0
Air flow per fan	(m ³ /hr)	16351	15958	15644	15644	15644	15646	15647	15644	15645	15642	15645	15646	15653
Power/motor	(kW)	1.12	1.12	1.12	1.12	1.12	1.12	1.12	1.12	1.12	1.12	1.12	1.12	1.12
Fan speed	(rps)	19	19	19	19	19	19	19	19	19	19	19	19	19
Tip speed	M/S	45	45	45	45	45	45	45	45	45	45	45	45	45
General Unit		HFC-134a												
# Refrig ckts	#	2	2	2	2	2	2	2	2	2	2	2	2	2
% min load	%	15	15	15	15	15	15	15	15	15	15	15	15	15
Refrigerant charge	(kg)	75/75	79/75	79/79	98/95	98/98	102/98	102/102	166/91	188/91	209/91	188/188	209/188	209/209
Oil charge	(L)	5/5	5/5	5/5	7/5	7/7	7/7	7/7	8-8/7	9-9/11	9-9/11	9-9/9-9	9-9/9-9	9-9/9-9
Min ambient-std	(°C)	-3.9	-3.9	-3.9	-3.9	-3.9	-3.9	-3.9	-3.9	-3.9	-3.9	-3.9	-3.9	-3.9
Min ambient-low	(°C)	-17.8	-17.8	-17.8	-17.8	-17.8	-17.8	-17.8	-17.8	-17.8	-17.8	-17.8	-17.8	-17.8

1. Data containing information on two circuits is shown as follows: ckt 1/ ckt 2.
 2. Minimum start-up/operating ambient is based on a 5 mph wind across the condenser.



Table 5. 60 Hz high efficiency – SI

Size		140	155	170	185	200	225	250	275	300	350	400
Compressor		Screw										
Quantity	#	2	2	2	2	2	2	2	3	3	4	4
Nominal size @60Hz	(tons)	70/70	85/70	85/85	100/85	100/100	120/100	120/120	85-85/100	100-100/100	85-85/85/85	100-100/100-100
Evaporator		Flooded										
Water storage	(L)	129	136	151	148	163	163	163	273	273	314	344
2 Pass arrangement												
Min flow	(L/s)	13	14	15	14	15	15	15	24	24	25	29
Max flow	(L/s)	47	50	56	50	56	56	56	87	87	94	107
Water connection	(NPS-in)	6	6	6	6	6	6	6	8	8	8	8
3 Pass arrangement												
Min flow	(L/s)	9	9	10	9	10	10	10	16	16	17	19
Max flow	(L/s)	31	34	37	34	37	37	37	58	58	62	71
Water connection	(NPS-in)	4	4	4	4	4	4	4	6	6	8	8
Condenser		Fin and tube										
Qty of coils	#	4	4	4	4	4	8	8	8	8	8	8
Coil length	(mm)	4572/ 4572	5486/ 4572	5486/ 5486	6400/ 5486	6400/ 6400	3657/ 3657	3657/ 3657	5486/ 3657	6400/ 3657	5486/ 5486	6400/ 6400
Coil height	(mm)	1067	1067	1067	1067	1067	1067	1067	1067	1067	1067	1067
Number of rows	#	192	192	192	192	192	192	192	192	192	192	192
Fins per foot	(fpf)	3	3	3	3	3	3	3	3	3	3	3
Fan		Direct drive propeller										
Quantity	#	5/5	6/5	6/6	7/6	7/7	8/6	8/8	12/6	14/6	12/12	14/14
Diameter	(mm)	762	762	762	762	762	762	762	762	762	762	762
Air per fan	(m ³ /hr)	15628	15628	15628	15629	15631	16619	15634	16397	16317	15628	15631
Power/motor	(kW)	1.12	1.12	1.12	1.12	1.12	1.12	1.12	1.12	1.12	1.12	1.12
Fan speed	(rps)	19	19	19	19	19	19	19	19	19	19	19
Tip speed	M/S	45	45	45	45	45	45	45	45	45	45	45
General Unit		HFC-134a										
# refrig ckts	#	2	2	2	2	2	2	2	2	2	2	2
% min load	%	15	15	15	15	15	15	15	15	15	15	15
Refrig charge	(kg)	79/79	98/93	98/98	102/98	102/102	107/107	107/107	188/91	209/91	188/188	209/209
Oil charge	(L)	5/5	5/5	5/5	7/5	7/7	7/7	7/7	8-8/7	9-9/7	8-8/8-8	9-9/9-9
Min ambient-std	(°C)	-3.9	-3.9	-3.9	-3.9	-3.9	-3.9	-3.9	-3.9	-3.9	-3.9	-3.9
Min ambient-low	(°C)	-17.8	-17.8	-17.8	-17.8	-17.8	-17.8	-17.8	-17.8	-17.8	-17.8	-17.8

1. Data containing information on two circuits is shown as follows: ckt 1/ ckt 2.
 2. Minimum start-up/operating ambient is based on a 5 mph wind across the condenser.

Table 6. 60 Hz extra efficiency – SI

Size		140	155	170	185	200	250	275	300	350
Compressor										
Quantity	#	2	2	2	2	2	3	3	4	4
Nominal size @60Hz	(tons)	85/85	100/85	100/100	120/100	120/120	85-85/100	100-100/100	85-85/85/85	100-100/100-100
Evaporator										
						Flooded				
Water storage	(L)	151	148	163	163	163	273	273	314	344
2 Pass arrangement										
Min flow	(L/s)	15	14	15	15	15	24	24	25	29
Max flow	(L/s)	56	50	56	56	56	87	87	94	107
Water connection	(NPS-in)	6	6	6	6	6	8	8	8	8
3 Pass arrangement										
Min flow	(L/s)	10	9	10	10	10	16	16	17	19
Max flow	(L/s)	37	34	37	37	37	58	58	62	71
Water connection	(NPS-in)	4	4	4	4	4	6	6	8	8
Condenser										
						Fin and tube				
Qty of coils	#	4	4	4	8	8	8	8	8	8
Coil length	(mm)	5486/5486	6400/5486	6400/6400	3657/3657	4572/2743	5486/3657	6400/3657	5486/5486	6400/6400
Coil height	(mm)	1067	1067	1067	1067	1067	1067	1067	1067	1067
Number of rows	#	192	192	192	192	192	192	192	192	192
Fins per foot	(fpf)	3	3	3	3	3	3	3	3	3
Fan										
						Direct drive propeller				
Quantity	#	6/6	7/6	7/7	8/6	8/8	12/6	14/6	12/12	14/14
Diameter	(mm)	762	762	762	762	762	762	762	762	762
Air per fan	(m ³ /hr)	15628	15629	15631	16619	15634	16397	16317	15628	15631
Power/motor	(kW)	1.12	1.12	1.12	1.12	1.12	1.12	1.12	1.12	1.12
Fan speed	(rps)	19	19	19	19	19	19	19	19	19
Tip speed	M/S	45	45	45	45	45	45	45	45	45
General Unit										
						HFC-134a				
# refrig ckts	#	2	2	2	2	2	2	2	2	2
% min load	%	15	15	15	15	15	15	15	15	15
Refrig charge	(kg)	98/98	102/98	102/102	107/107	107/107	188/91	209/91	188/188	209/209
Oil charge	(L)	5/5	7/5	7/7	7/7	7/7	8-8/7	8-8/7	8-8/8-8	8-8/8-8
Min ambient-std	(°C)	-3.9	-3.9	-3.9	-3.9	-3.9	-3.9	-3.9	-3.9	-3.9
Min ambient-low	(°C)	-17.8	-17.8	-17.8	-17.8	-17.8	-17.8	-17.8	-17.8	-17.8

1. Data containing information on two circuits is shown as follows: ckt 1/ ckt 2.
 2. Minimum start-up/operating ambient is based on a 5 mph wind across the condenser.



Performance Data

Table 1. 60 Hz standard efficiency – I-P units

Evap Leaving Water Temp (°F)	Cond Entering Air Temp (°F)												
	Unit Size	85			95			105			115		
		Tons	kW Input ²	EER ³	Tons	kW Input ²	EER ³	Tons	kW Input ²	EER ³	Tons	kW Input ²	EER ³
40	140	138.1	139.6	10.9	128.3	151.9	9.4	118.3	165.8	8	108	181.2	6.7
	155	151.5	151.6	11	141	165	9.5	130.1	180.1	8.1	119	196.9	6.8
	170	165.6	163.8	11.1	154.4	178.5	9.6	142.7	194.9	8.2	130.9	213.2	6.9
	185	181.5	182	10.9	169.2	197.8	9.5	156.6	215.5	8.1	143.6	235.4	6.8
	200	198.5	201	10.9	185.1	217.8	9.4	171.3	236.9	8.1	156.9	258.3	6.8
	225	218	221.6	10.8	203.6	240.2	9.4	188.6	261.2	8.1	173.1	284.8	6.8
	250	239.1	243.3	10.8	223.5	263.6	9.4	207.2	286.6	8.1	190.2	312.4	6.9
	275	265.5	266.3	10.9	247.6	289.2	9.5	229.1	315.1	8.1	210.2	344	6.9
	300	298.4	304.8	10.8	278.3	329.8	9.4	257.6	358.3	8	236.3	390.2	6.8
	350	338.9	348.7	10.7	316.6	377.1	9.3	293.4	409.3	8	269.3	445.4	6.8
	400	400.7	409.7	10.8	374.1	443.2	9.4	346.4	481.3	8	317.9	524	6.8
	450	440.8	453.5	10.7	412	490.4	9.3	382	532.4	8	350.9	579.4	6.8
	500	482.4	498.3	10.7	451.1	538.5	9.3	418.5	584.2	8	384.5	635.4	6.8
42	140	143.4	142.6	11.1	133.3	155	9.6	122.9	168.9	8.1	112.2	184.4	6.9
	155	157.3	154.8	11.2	146.4	168.3	9.6	135.2	183.5	8.2	123.7	200.4	6.9
	170	171.8	167.3	11.3	160.2	182	9.7	148.3	198.6	8.3	136	217	7
	185	188.2	185.9	11.1	175.6	201.8	9.6	162.5	219.7	8.3	149.1	239.6	7
	200	205.8	205.4	11	192	222.4	9.6	177.7	241.6	8.2	162.9	263.1	7
	225	225.9	226.5	11	211.1	245.3	9.6	195.6	266.5	8.2	179.6	290.3	7
	250	247.9	248.8	11	231.7	269.3	9.6	214.8	292.6	8.2	197.3	318.6	7
	275	275.3	272	11.1	256.8	295.1	9.6	237.8	321.1	8.3	218.3	350.2	7
	300	309.3	311.6	10.9	288.6	336.8	9.5	267.2	365.4	8.2	245.2	397.5	6.9
	350	351.3	356.7	10.9	328.2	385.3	9.5	304.2	417.8	8.2	279.3	454.3	6.9
	400	415.1	418.8	10.9	387.6	452.6	9.5	359.1	490.9	8.2	329.7	533.8	7
	450	456.6	463.7	10.9	426.8	500.9	9.5	395.8	543.2	8.2	363.7	590.7	6.9
	500	499.7	509.7	10.9	467.4	550.3	9.5	433.6	596.4	8.2	398.5	648.3	6.9
44	140	148.7	145.6	11.3	138.3	158.1	9.7	127.6	172.1	8.3	116.6	187.7	7
	155	163.1	158.1	11.4	151.9	171.7	9.8	140.3	187	8.4	128.5	204	7.1
	170	178.1	170.8	11.5	166.1	185.6	9.9	153.8	202.3	8.5	141.3	220.8	7.2
	185	195	189.9	11.3	182	205.9	9.8	168.5	223.9	8.4	154.7	244	7.1
	200	213.2	210	11.2	198.9	227.1	9.7	184.2	246.4	8.4	169	268.1	7.1
	225	234	231.6	11.2	218.6	250.5	9.7	202.7	271.9	8.4	186.1	295.9	7.1
	250	256.8	254.5	11.2	240.1	275.2	9.7	222.6	298.7	8.4	204.4	325	7.1
	275	285.3	277.9	11.3	266.2	301.1	9.8	246.6	327.3	8.4	226.5	356.5	7.2
	300	320.3	318.6	11.1	299	343.9	9.7	276.9	372.7	8.3	254.2	405	7.1
	350	363.9	364.9	11	340	393.7	9.6	315.2	426.5	8.3	289.5	463.3	7.1
	400	429.7	428.1	11.1	401.3	462.1	9.7	371.9	500.6	8.3	341.6	543.7	7.1
	450	472.6	474.1	11	441.9	511.7	9.6	409.9	554.3	8.3	376.7	602.2	7.1
	500	517.3	521.4	11	483.9	562.4	9.6	449	609	8.3	412.6	661.4	7.1

Table 1. 60 Hz standard efficiency – I-P units

Evap Leaving Water Temp (°F)	Cond Entering Air Temp (°F)												
	85				95				105				115
	Unit Size	Tons	kW Input ²	EER ³	Tons	kW Input ²	EER ³	Tons	kW Input ²	EER ³	Tons	kW Input ²	EER ³
46	140	154.1	148.8	11.5	143.4	161.3	9.9	132.3	175.4	8.5	121	191	7.2
	155	169	161.5	11.6	157.4	175.2	10	145.6	190.5	8.6	133.4	207.6	7.2
	170	184.5	174.4	11.7	172.2	189.3	10.1	159.5	206.1	8.7	146.6	224.7	7.3
	185	201.9	194.1	11.5	188.5	210.1	10	174.6	228.3	8.6	160.4	248.5	7.3
	200	220.7	214.7	11.4	206	231.9	9.9	190.8	251.3	8.5	175.1	273.1	7.2
	225	242.1	236.8	11.3	226.3	255.8	9.9	209.8	277.5	8.5	192.8	301.7	7.2
	250	265.8	260.2	11.3	248.5	281.2	9.9	230.5	304.9	8.5	211.6	331.6	7.2
	275	295.4	284	11.5	275.8	307.3	10	255.6	333.6	8.6	234.9	362.9	7.3
	300	331.5	325.7	11.3	309.5	351.2	9.8	286.7	380.2	8.5	263.3	412.6	7.2
	350	376.6	373.3	11.2	352	402.4	9.8	326.3	435.4	8.4	297.3	467.6	7.2
	400	444.4	437.6	11.2	415.2	471.8	9.8	384.9	510.5	8.5	353.7	553.8	7.2
	450	488.8	484.8	11.2	457.1	522.7	9.8	424.1	565.7	8.4	384.5	602.6	7.2
	500	535.2	533.4	11.2	500.7	574.8	9.7	464.5	621.9	8.4	416.8	652.5	7.2
48	140	159.6	152	11.7	148.5	164.6	10.1	137.1	178.7	8.6	124.5	192.8	7.3
	155	175	164.9	11.7	163.1	178.7	10.2	150.8	194.2	8.7	137.3	209.6	7.4
	170	190.9	178.1	11.8	178.3	193.1	10.3	165.3	210	8.8	152	228.6	7.5
	185	208.9	198.3	11.6	195.1	214.5	10.1	180.8	232.7	8.7	166.2	253	7.4
	200	228.2	219.4	11.5	213.1	236.7	10	197.4	256.3	8.6	181.3	278.1	7.4
	225	250.4	242	11.5	234.1	261.3	10	217.1	283.1	8.6	199.5	307.5	7.3
	250	275	266.2	11.5	257.1	287.3	10	238.4	311.3	8.6	216	331.7	7.4
	275	305.7	290.2	11.7	285.4	313.6	10.1	264.7	340	8.7	243.3	369.5	7.4
	300	342.8	333	11.4	320.1	358.7	10	296.7	387.7	8.6	272.5	420.3	7.3
	350	389.6	381.8	11.3	364.1	411.2	9.9	337.5	444.5	8.5	301.2	462.7	7.3
	400	459.4	447.4	11.4	429.2	481.7	9.9	398.1	520.6	8.6	363.2	558.7	7.3
	450	505.3	495.8	11.3	472.6	533.9	9.9	438.5	577.3	8.5	389.9	597.2	7.4
	500	553.4	545.7	11.3	517.7	587.5	9.9	480.3	635.2	8.5	421.5	644.1	7.4

1. Rated in accordance with AHRI Standard 550/590 based on TOPSS version 140: sea level altitude, evaporator fouling factor of 0.0001°F-ft²/Btu, evaporator temperature drop of 10°F, and 2 pass evaporator configuration. Consult a Trane representative for additional performance information.

2. kW input is for compressors only.

3. EER = Energy Efficiency Ratio (Btu/watt-hour). Power inputs include compressors, condenser fans and control power.

4. Interpolation between points is permissible. Extrapolation is not permitted.



Performance Data

Table 2. 60 Hz high efficiency – I-P units

Evap Leaving Water Temp (°F)	Cond Entering Air Temp (°F)												
	Unit Size	85			95			105			115		
		Tons	kW Input ²	EER ³	Tons	kW Input ²	EER ³	Tons	kW Input ²	EER ³	Tons	kW Input ²	EER ³
40	140	141.1	134.3	11.3	131.4	145.8	9.8	121.4	158.8	8.4	111.1	173.5	7.1
	155	156.2	145.2	11.5	145.6	157.9	10	134.7	172.3	8.6	123.5	188.4	7.2
	170	170.1	156.6	11.7	158.7	170.4	10.1	147	186.1	8.6	134.9	203.6	7.3
	185	186.9	175.1	11.5	174.6	190	10	161.8	206.9	8.6	148.7	225.9	7.3
	200	204.8	194.4	11.4	191.4	210.2	9.9	177.4	228.3	8.5	163.1	248.7	7.3
	225	221.3	215.8	11.2	207.2	233.2	9.8	192.5	253.1	8.4	177.2	275.5	7.2
	250	244.1	236.8	11.2	228.8	255.9	9.8	212.8	277.7	8.5	196.1	302.3	7.2
	275	273.5	256.1	11.6	255.4	277.6	10.1	236.8	302.2	8.6	217.7	329.8	7.3
	300	306.7	294.5	11.3	286.8	318	9.9	266.1	344.9	8.5	244.8	375.2	7.3
	350	344.2	318.4	11.6	321.6	346	10.1	298.2	377.3	8.7	274.3	412.4	7.3
42	400	413	396.6	11.3	386.3	428	9.9	358.5	463.9	8.5	329.9	504.4	7.3
	140	146.6	137	11.5	136.7	148.6	10	126.3	161.8	8.6	115.7	176.5	7.3
	155	162.3	148.2	11.8	151.4	161	10.2	140.2	175.4	8.8	128.6	191.6	7.4
	170	176.7	159.8	11.9	165	173.7	10.3	152.9	189.5	8.8	140.5	207.1	7.5
	185	194	178.8	11.7	181.3	193.8	10.2	168.2	210.8	8.8	154.7	229.9	7.5
	200	212.6	198.7	11.6	198.7	214.6	10.1	184.3	232.8	8.7	169.5	253.2	7.4
	225	229.7	220.6	11.4	215.1	238.1	10	199.9	258.1	8.6	184.1	280.7	7.3
	250	253.3	242.1	11.4	237.5	261.3	10	220.9	283.3	8.6	203.6	308.2	7.4
	275	284	261.5	11.8	265.4	283.2	10.3	246.2	307.9	8.8	226.5	335.6	7.5
	300	318.4	301	11.5	297.8	324.6	10.1	276.4	351.6	8.7	254.4	382.1	7.4
44	350	357.3	324.9	11.8	333.9	352.7	10.3	309.9	384.1	8.9	285.2	419.4	7.5
	400	428.4	405.3	11.5	400.8	436.8	10	372.2	472.9	8.7	342.7	513.6	7.4
	140	152.3	139.9	11.8	142	151.5	10.2	131.4	164.8	8.8	120.4	179.5	7.4
	155	168.5	151.3	12	157.3	164.1	10.4	145.7	178.6	9	133.8	194.9	7.6
	170	183.4	163.1	12.1	171.3	177.1	10.5	158.9	192.9	9	146.1	210.6	7.7
	185	201.3	182.6	11.9	188.2	197.6	10.4	174.6	214.7	9	160.7	233.9	7.6
	200	220.5	203.1	11.8	206.2	219	10.3	191.3	237.3	8.9	176	257.9	7.6
	225	238.2	225.6	11.6	223.2	243.2	10.1	207.5	263.3	8.8	191.2	286.1	7.5
	250	262.7	247.5	11.6	246.3	266.9	10.2	229.2	289.1	8.8	211.3	314.2	7.5
	275	294.7	267.1	12	275.5	288.9	10.5	255.7	313.7	9	235.4	341.5	7.7
300	330.2	307.7	11.7	308.9	331.4	10.3	286.8	358.5	8.9	264.1	389.1	7.6	
350	370.5	331.6	12.1	346.5	359.5	10.5	321.8	391.1	9	296.4	426.5	7.7	
400	444.1	414.3	11.7	415.6	445.9	10.2	386.1	482.2	8.8	355.6	523	7.6	

Table 2. 60 Hz high efficiency – I-P units

Evap Leaving Water Temp (°F)	Cond Entering Air Temp (°F)												
	Unit Size	85			95			105			115		
		Tons	kW Input ²	EER ³	Tons	kW Input ²	EER ³	Tons	kW Input ²	EER ³	Tons	kW Input ²	EER ³
46	140	158	142.8	12	147.4	154.5	10.4	136.5	167.8	9	125.2	182.7	7.6
	155	174.8	154.4	12.2	163.2	167.3	10.6	151.3	181.9	9.2	139.1	198.2	7.8
	170	190.3	166.4	12.3	177.8	180.5	10.7	165	196.4	9.2	151.9	214.2	7.9
	185	208.6	186.5	12.1	195.1	201.6	10.6	181.2	218.7	9.1	166.9	238	7.8
	200	228.5	207.5	12	213.7	223.6	10.5	198.4	241.9	9.1	182.7	262.6	7.7
	225	246.9	230.6	11.8	231.3	248.3	10.3	215.1	268.6	8.9	198.3	291.5	7.6
	250	272.2	253.1	11.8	255.3	272.6	10.3	237.6	295	8.9	219.1	320.4	7.7
	275	305.6	272.9	12.2	285.8	294.7	10.7	265.4	319.6	9.2	244.4	347.5	7.8
	300	342.1	314.5	11.9	320.2	338.3	10.4	297.5	365.6	9	274	396.3	7.7
	350	384	338.5	12.3	359.3	366.5	10.7	333.9	398.2	9.2	307.8	433.7	7.9
48	400	459.9	423.4	11.8	430.6	455.2	10.4	400.2	491.6	9	368.8	532.6	7.7
	140	163.9	145.8	12.2	153	157.6	10.6	141.7	170.9	9.1	129	184.2	7.8
	155	181.2	157.6	12.5	169.3	170.6	10.8	157.1	185.2	9.3	143.7	200.4	8
	170	197.2	169.9	12.6	184.4	184	10.9	171.2	200	9.4	157.7	217.9	8
	185	216.1	190.5	12.3	202.2	205.6	10.8	187.9	222.8	9.3	173.1	242.2	8
	200	236.6	212.1	12.2	221.4	228.2	10.7	205.7	246.6	9.2	189.4	267.3	7.9
	225	255.7	235.8	11.9	239.6	253.6	10.5	222.9	274	9.1	205.5	297.1	7.8
	250	281.9	258.7	12	264.5	278.4	10.5	246.1	301.1	9.1	226	324.8	7.8
	275	316.7	278.7	12.4	296.2	300.7	10.8	275.2	325.6	9.4	253.7	353.6	8
	300	354.3	321.5	12.1	331.6	345.4	10.6	308.2	372.7	9.2	284.1	403.6	7.9
350	397.8	345.5	12.5	372.3	373.6	10.9	346.2	405.5	9.4	319.4	441	8	
400	476	432.8	12	445.8	464.7	10.6	414.5	501.2	9.2	382.1	542.4	7.9	

1. Rated in accordance with AHRI Standard 550/590 based on TOPSS version 140: sea level altitude, evaporator fouling factor of 0.0001 °F-ft²h/Btu, evaporator temperature drop of 10°F, and 2 pass evaporator configuration. Consult a Trane representative for additional performance information.
2. kW input is for compressors only.
3. EER = Energy Efficiency Ratio (Btu/watt-hour). Power inputs include compressors, condenser fans and control power.
4. Interpolation between points is permissible. Extrapolation is not permitted.



Performance Data

Table 3. 60 Hz extra efficiency – I-P units

Evap Leaving Water Temp (°F)	Cond Entering Air Temp (°F)												
	Unit Size	85			95			105			115		
		Tons	kW Input ²	EER ³	Tons	kW Input ²	EER ³	Tons	kW Input ²	EER ³	Tons	kW Input ²	EER ³
40	140	146	129.3	11.8	136.1	140.2	10.3	125.8	152.6	8.8	114.9	166.6	7.5
	155	160.8	140.3	12	150.1	152.4	10.5	139.1	166.2	9	127.4	181.7	7.6
	170	176.3	151.7	12.2	164.7	164.9	10.6	152.8	180	9.1	140.1	196.8	7.7
	185	189.4	170.9	11.8	177.2	184.9	10.3	164.6	201	8.9	150.9	219	7.6
	200	207.9	190	11.6	194.6	205	10.2	180.9	222.2	8.8	165.7	241.5	7.5
	250	234.9	206.6	12	219.3	224	10.5	203.1	243.9	9	185.7	266.2	7.6
	275	264	229.4	12.2	246.8	249.1	10.6	229.2	271.6	9.1	210.1	296.6	7.7
	300	295.9	262.3	11.8	276.2	284.1	10.3	255.8	309.1	8.9	233.5	337	7.5
	350	355.9	308.8	12.1	332.9	335	10.6	309.1	365	9.1	283.2	398.4	7.7
42	140	151.9	131.9	12.1	141.7	142.9	10.5	131.1	155.4	9.1	119.9	169.4	7.7
	155	167.2	143.1	12.3	156.2	155.3	10.7	144.8	169.2	9.2	132.8	184.7	7.8
	170	183.3	154.7	12.5	171.4	168	10.9	159.1	183.2	9.3	146	200.1	7.9
	185	196.8	174.5	12.1	184.3	188.6	10.5	171.2	204.8	9.1	157.2	222.8	7.8
	200	216	194.1	11.8	202.3	209.1	10.4	188.1	226.4	9	172.4	245.8	7.7
	250	244.3	210.8	12.3	228.2	228.3	10.7	211.6	248.3	9.2	193.6	270.7	7.8
	275	274.4	234.1	12.4	256.7	253.8	10.8	238.5	276.4	9.3	218.9	301.5	7.9
	300	307.6	267.6	12.1	287.3	289.6	10.6	266.3	314.6	9.1	243.4	342.6	7.7
	350	369.8	315	12.4	346	341.4	10.8	321.6	371.4	9.3	295	405	7.9
44	140	158	134.6	12.4	147.5	145.6	10.8	136.6	158.2	9.3	125	172.3	7.9
	155	173.7	146	12.5	162.4	158.2	10.9	150.7	172.2	9.4	138.3	187.7	8
	170	190.4	157.9	12.7	178.1	171.2	11.1	165.5	186.4	9.6	152	203.4	8.1
	185	204.4	178.2	12.3	191.5	192.3	10.8	178	208.6	9.3	163.5	226.7	7.9
	200	224.2	198.4	12.1	210.1	213.4	10.6	195.5	230.8	9.2	179.3	250.2	7.9
	250	253.9	215.1	12.5	237.3	232.7	11	220.2	252.8	9.4	201.7	275.2	8
	275	285	238.8	12.7	266.8	258.6	11.1	248.1	281.3	9.6	227.9	306.5	8.1
	300	319.6	273.1	12.4	298.7	295.1	10.8	277	320.3	9.3	253.4	348.4	7.9
	350	383.9	321.4	12.6	359.5	347.9	11	334.3	378	9.6	307	411.6	8.1
46	140	164.2	137.3	12.6	153.3	148.4	11	142.1	161	9.5	130.2	175.2	8.1
	155	180.4	149	12.8	168.7	161.2	11.2	156.7	175.2	9.7	143.9	190.8	8.2
	170	197.7	161.1	13	185	174.4	11.3	172	189.7	9.8	158.2	206.7	8.3
	185	212.2	182	12.5	198.8	196.2	11	185	212.4	9.5	170	230.6	8.1
	200	232.5	202.7	12.3	218	217.8	10.8	202.9	235.2	9.4	186.3	254.7	8
	250	263.7	219.6	12.8	246.6	237.2	11.2	229	257.3	9.7	209.9	279.8	8.2
	275	295.9	243.7	12.9	277.1	263.6	11.3	257.8	286.2	9.8	237.1	311.5	8.3
	300	331.8	278.7	12.6	310.3	300.8	11	288	326	9.5	263.6	354.2	8.1
	350	398.3	328	12.9	373.2	354.5	11.3	347.3	384.7	9.8	319.1	418.4	8.3

Table 3. 60 Hz extra efficiency – I-P units

Evap Leaving Water Temp (°F)	Cond Entering Air Temp (°F)															
	85				95				105				115			
	Unit Size	Tons	kW Input ²	EER ³	Tons	kW Input ²	EER ³	Tons	kW Input ²	EER ³	Tons	kW Input ²	EER ³			
48	140	170.5	140.2	12.9	159.3	151.3	11.3	147.7	164	9.7	135.4	178.1	8.3			
	155	187.2	152	13.1	175.2	164.3	11.4	162.8	178.3	9.9	149.6	194	8.4			
	170	205.1	164.3	13.2	192.1	177.7	11.6	178.6	193	10	164.4	210.1	8.6			
	185	220	185.9	12.7	206.2	200.1	11.2	192	216.4	9.7	176.6	234.6	8.3			
	200	241	207.1	12.5	226.1	222.2	11	210.5	239.7	9.6	193.3	259.3	8.2			
	250	273.7	224.1	13	256.1	241.8	11.4	237.9	262	9.9	218.3	284.5	8.4			
	275	306.9	248.7	13.2	287.6	268.6	11.6	267.7	291.3	10	246.4	316.7	8.5			
	300	344.3	284.4	12.8	322.1	306.6	11.3	299.1	331.9	9.8	273.9	360.1	8.3			
	350	413	334.7	13.1	387.1	361.3	11.5	360.5	391.6	10	331.5	425.3	8.5			

1. Rated in accordance with AHRI Standard 550/590 based on TOPSS version 140: sea level altitude, evaporator fouling factor of 0.0001 °F-ft²h/Btu, evaporator temperature drop of 10°F, and 2 pass evaporator configuration. Consult a Trane representative for additional performance information.
2. kW input is for compressors only.
3. EER = Energy Efficiency Ratio (Btu/watt-hour). Power inputs include compressors, condenser fans and control power.
4. Interpolation between points is permissible. Extrapolation is not permitted.

Table 4. AHRI and Part Load Performance – 60 Hz – I-P units

Standard efficiency				High efficiency				Extra efficiency			
Unit Size	Full Load Tons	Full Load EER	IPLV	Unit Size	Full Load Tons	Full Load EER	IPLV	Unit Size	Full Load Tons	Full Load EER	IPLV
140	138.3	9.7	13.6	140	142.0	10.2	13.8	140	147.5	10.8	14.3
155	151.9	9.8	14.0	155	157.3	10.4	14.5	155	162.4	10.9	14.9
170	166.1	9.9	14.0	170	171.3	10.5	14.5	170	178.1	11.1	14.9
185	182.0	9.8	13.9	185	188.2	10.4	14.3	185	191.4	10.8	14.8
200	198.9	9.7	13.6	200	206.1	10.3	14.1	200	210.1	10.6	14.1
225	218.6	9.7	13.9	225	223.2	10.1	14.1	250	237.3	11.0	14.8
250	240.1	9.7	13.7	250	246.3	10.2	14.0	275	266.8	11.1	15.2
275	266.2	9.8	14.6	275	275.5	10.5	14.8	300	298.7	10.8	14.8
300	298.9	9.7	14.2	300	308.9	10.3	14.4	350	359.5	11.0	15.3
350	340.0	9.6	14.3	350	346.5	10.5	15.4				
400	401.3	9.7	14.7	400	415.6	10.2	14.7				
450	441.8	9.6	15.0								
500	483.9	9.6	15.0								

1. IPLV values are rated in accordance with AHRI Standard 550/590 and based on TOPSS version 140.
2. EER and IPLV values include compressors, condenser fans, and control kW.



Performance Data

Table 5. 60 Hz standard efficiency – SI units

Evap Leaving Water Temp (°C)	Cond Entering Air Temp (°C)												
	30			35			40			45			
	Unit Size	kW Cooling	kW Input ²	COP ³	kW Cooling	kW Input ²	COP ³	kW Cooling	kW Input ²	COP ³	kW Cooling	kW Input ²	COP ³
5	140	490.83	142.2	3.17	459.54	153.4	2.77	427.19	165.8	2.4	394.14	179.5	2.06
	155	538.65	154.3	3.2	504.55	166.6	2.8	469.74	180.1	2.42	434.23	195.1	2.08
	170	588.58	166.8	3.23	552.36	180.1	2.83	515.09	194.9	2.45	477.12	211.2	2.11
	185	645.19	185.3	3.19	605.46	199.7	2.8	565.02	215.6	2.43	523.53	233.3	2.1
	200	705.31	204.6	3.16	662.41	220	2.78	617.76	237.1	2.42	572.05	256.1	2.09
	225	774.58	225.6	3.15	728.16	242.6	2.78	679.99	261.5	2.42	630.42	282.5	2.09
	250	849.47	247.8	3.16	799.19	266.2	2.78	746.8	286.9	2.43	692.65	309.8	2.1
	275	942.99	271.1	3.19	885.33	291.9	2.8	826.26	315.1	2.44	765.79	340.8	2.1
	300	1059.72	310.2	3.13	995.03	333	2.76	928.93	358.6	2.41	860.72	386.9	2.08
	350	1203.53	355	3.12	1131.8	380.8	2.75	1057.26	409.8	2.41	980.61	441.9	2.08
400	1423.28	417.1	3.13	1337.49	447.6	2.76	1248.88	481.7	2.41	1157.82	519.6	2.09	
450	1565.32	461.6	3.12	1472.5	495.2	2.75	1376.51	532.9	2.41	1277.36	574.7	2.08	
500	1713.35	507.4	3.11	1612.79	544	2.75	1508.01	585	2.41	1399.72	630.7	2.08	
7	140	524.24	147.6	3.27	490.83	159	2.87	456.73	171.5	2.49	421.92	185.4	2.14
	155	575.22	160.3	3.3	539.35	172.6	2.89	502.44	186.3	2.51	465.17	201.5	2.16
	170	627.96	173.2	3.33	589.63	186.6	2.92	550.61	201.6	2.54	510.88	218	2.19
	185	687.73	192.6	3.28	645.89	207.1	2.89	603.35	223.2	2.52	559.4	241.1	2.17
	200	751.72	212.9	3.25	706.01	228.4	2.86	659.25	245.7	2.5	610.73	264.9	2.16
	225	825.21	234.7	3.24	775.98	251.9	2.86	725	271.2	2.5	672.61	292.5	2.16
	250	905.37	257.9	3.24	851.93	276.7	2.86	796.37	297.8	2.5	738.36	321.2	2.16
	275	1005.58	281.7	3.28	944.75	302.7	2.89	882.52	326.2	2.52	818.53	352.1	2.18
	300	1128.99	322.8	3.22	1060.43	345.8	2.84	990.46	371.6	2.48	918.38	400.2	2.15
	350	1282.64	369.7	3.2	1205.99	395.9	2.83	1126.88	425.3	2.48	1045.31	457.9	2.15
400	1514.69	433.8	3.22	1423.98	464.7	2.84	1330.45	499.2	2.49	1234.12	537.4	2.15	
450	1665.88	480.4	3.2	1567.43	514.5	2.83	1465.82	552.8	2.48	1360.34	595.2	2.15	
500	1824.1	528.4	3.19	1717.22	565.7	2.83	1605.76	607.5	2.47	1490.43	654	2.14	
9	140	558.34	153.4	3.37	523.18	164.8	2.96	487.32	177.5	2.57	450.4	191.4	2.21
	155	612.49	166.5	3.4	574.87	178.9	2.98	536.19	192.8	2.6	496.46	208	2.24
	170	668.39	179.8	3.42	628.31	193.4	3.01	587.17	208.5	2.63	544.98	225	2.27
	185	731.33	200.1	3.37	687.38	214.8	2.97	642.37	231.1	2.59	596.31	249.1	2.25
	200	798.84	221.4	3.33	750.67	237.1	2.94	701.09	254.6	2.57	650.46	273.9	2.23
	225	876.89	244.2	3.32	825.21	261.7	2.93	771.06	281.2	2.57	715.51	302.8	2.22
	250	962.68	268.5	3.32	906.07	287.7	2.93	846.65	309.2	2.57	785.47	333.1	2.22
	275	1069.92	292.8	3.37	1005.58	314	2.97	939.83	337.6	2.6	872.67	363.7	2.25
	300	1199.66	335.9	3.3	1127.58	359.1	2.92	1053.39	385.1	2.56	977.1	413.9	2.22
	350	1363.51	385.1	3.28	1282.64	411.7	2.9	1198.6	441.5	2.54	1108.6	472.8	2.21
400	1608.22	451.3	3.3	1512.58	482.4	2.92	1413.78	517.2	2.56	1312.17	555.8	2.22	
450	1768.9	500.1	3.28	1664.83	534.7	2.9	1557.24	573.4	2.54	1439.45	612.7	2.21	
500	1937.67	550.5	3.27	1824.1	588.4	2.89	1705.61	631	2.54	1567.78	668.8	2.21	

1. Ratings based on TOPSS version 140: evaporator fouling factor of 0.01761m²°C/kW, evaporator temperature drop of 5°C, and 2 pass evaporator configuration. Consult Trane representative for additional performance information.

2. kW input is for compressors only.

3. COP = Coefficient of Performance. Power inputs include compressors and control power.

4. Interpolation between points is permissible. Extrapolation is not permitted.

Table 6. 60 Hz high efficiency – SI units

Evap Leaving Water Temp (°C)	Cond Entering Air Temp (°C)												
	30			35			40			45			
	Unit Size	kW Cooling	kW Input ²	COP ³	kW Cooling	kW Input ²	COP ³	kW Cooling	kW Input ²	COP ³	kW Cooling	kW Input ²	COP ³
5	140	501.73	136.7	3.29	470.79	147.1	2.9	438.8	158.9	2.52	406.1	171.9	2.17
	155	555.88	147.8	3.37	521.77	159.4	2.96	486.97	172.3	2.58	451.1	186.6	2.22
	170	605.1	159.4	3.4	568.54	172	2.99	530.92	186.1	2.6	492.59	201.7	2.24
	185	664.52	178.3	3.35	624.79	191.8	2.95	584.01	206.9	2.58	542.17	223.8	2.23
	200	727.81	197.9	3.32	684.92	212.3	2.93	640.26	228.5	2.57	594.2	246.5	2.22
	225	786.88	219.7	3.27	741.52	235.5	2.89	694.41	253.3	2.53	645.54	273.3	2.2
	250	867.75	241	3.27	818.53	258.4	2.9	767.19	278	2.54	713.75	299.9	2.21
	275	972.53	260.6	3.37	914.51	280.2	2.97	854.74	302.2	2.6	793.91	326.8	2.25
	300	1090.31	299.7	3.3	1025.97	321	2.92	959.87	345.1	2.56	891.66	372.1	2.22
	350	1223.92	324.1	3.39	1151.14	349.1	2.98	1076.25	377.2	2.6	999.95	408.4	2.25
400	1467.93	403.6	3.29	1382.14	432.1	2.91	1293.19	464.3	2.55	1201.77	500.3	2.22	
7	140	537.25	141.8	3.41	504.55	152.3	3.01	470.79	164.2	2.62	435.98	177.3	2.27
	155	594.56	153.3	3.49	558.69	165	3.07	522.13	178	2.68	484.15	192.4	2.32
	170	647.3	165.3	3.52	608.62	178	3.1	568.89	192.2	2.71	528.46	207.9	2.34
	185	709.88	185.1	3.46	668.04	198.7	3.06	625.15	214	2.68	580.84	231	2.32
	200	777.39	205.7	3.42	731.68	220.2	3.03	684.57	236.6	2.66	636.04	254.8	2.31
	225	840.32	228.5	3.36	792.16	244.5	2.98	742.23	262.6	2.62	690.54	282.8	2.28
	250	926.82	250.8	3.37	874.43	268.4	2.99	819.93	288.3	2.63	762.97	310.5	2.28
	275	1039.68	270.7	3.48	978.15	290.4	3.08	915.22	312.6	2.7	850.52	337.3	2.34
	300	1164.15	311.7	3.4	1096.29	333.2	3.02	1025.97	357.5	2.65	953.89	384.6	2.3
	350	1306.9	336.1	3.5	1230.25	361.4	3.09	1151.49	389.7	2.7	1071.33	421.1	2.35
400	1566.03	419.7	3.38	1475.31	448.4	3.01	1381.44	480.8	2.64	1284.75	517.1	2.3	
9	140	573.81	147.1	3.53	539	157.8	3.11	503.49	169.7	2.72	466.92	182.9	2.36
	155	634.64	159	3.6	597.02	170.8	3.18	557.99	183.9	2.78	518.26	198.4	2.41
	170	690.54	171.5	3.63	649.76	184.3	3.21	608.27	198.6	2.81	565.72	214.4	2.44
	185	757	192.2	3.57	712.69	205.9	3.16	667.34	221.3	2.77	620.93	238.4	2.41
	200	828.37	213.9	3.52	780.2	228.5	3.12	730.27	245	2.75	678.94	263.3	2.39
	225	895.53	237.8	3.46	844.54	254	3.07	791.45	272.2	2.7	736.6	292.6	2.35
	250	987.29	261	3.46	932.09	278.8	3.08	874.08	299.1	2.71	813.6	321.7	2.36
	275	1108.6	281.2	3.59	1043.9	301.1	3.18	977.45	323.4	2.79	909.24	348.2	2.43
	300	1240.45	324.2	3.5	1168.37	345.8	3.11	1094.18	370.3	2.74	1018.23	397.5	2.39
	350	1393.04	348.6	3.61	1312.17	374.1	3.19	1229.55	402.6	2.8	1144.81	434.1	2.44
400	1666.94	436.4	3.48	1570.95	465.3	3.09	1471.8	498	2.73	1369.83	534.4	2.38	

1. Ratings based on TOPSS version 140: evaporator fouling factor of 0.01761m²°C/kW, evaporator temperature drop of 5°C, and 2 pass evaporator configuration. Consult Trane representative for additional performance information.
2. kW input is for compressors only.
3. COP = Coefficient of Performance. Power inputs include compressors and control power.
4. Interpolation between points is permissible. Extrapolation is not permitted.



Performance Data

Table 7. 60 Hz extra efficiency — SI units

Evap Leaving Water Temp (°C)	Cond Entering Air Temp (°C)												
	30			35			40			45			
	Unit Size	kW Cooling	kW Input ²	COP ³	kW Cooling	kW Input ²	COP ³	kW Cooling	kW Input ²	COP ³	kW Cooling	kW Input ²	COP ³
5	140	519.66	131.5	3.46	488.02	141.5	3.05	455.32	152.7	2.66	421.57	165.1	2.3
	155	572.05	142.8	3.51	537.95	153.8	3.1	502.44	166.2	2.7	466.22	180	2.34
	170	627.25	154.4	3.56	589.98	166.4	3.14	552.01	179.9	2.75	512.63	194.9	2.38
	185	674.02	173.9	3.45	634.64	186.7	3.05	594.2	201.1	2.68	552.01	217.1	2.32
	200	739.41	193.3	3.39	696.87	206.9	3.01	652.92	222.3	2.65	605.46	239.5	2.3
	250	835.75	210.2	3.51	785.83	226	3.1	734.14	243.9	2.71	680.35	263.8	2.34
	275	939.12	233.4	3.55	883.92	251.3	3.14	827.67	271.4	2.75	768.6	293.7	2.38
	300	1053.04	266.9	3.46	989.75	286.7	3.06	924.71	309.1	2.68	855.79	334	2.31
	350	1266.11	314.2	3.54	1192.28	338	3.13	1116.33	364.9	2.74	1036.17	394.7	2.37
7	140	557.64	136.4	3.6	524.24	146.4	3.18	489.43	157.6	2.78	453.92	170.2	2.41
	155	613.19	148	3.65	576.98	159	3.22	539.71	171.5	2.82	501.38	185.4	2.45
	170	671.91	160	3.7	632.88	172.1	3.27	592.45	185.7	2.87	551.31	200.8	2.49
	185	721.48	180.5	3.57	679.99	193.4	3.17	637.45	207.9	2.79	592.45	224.1	2.42
	200	791.1	200.9	3.51	746.1	214.6	3.12	699.33	230.1	2.75	649.05	247.4	2.4
	250	896.23	217.9	3.65	843.14	233.9	3.23	788.64	251.9	2.83	731.68	271.9	2.45
	275	1005.58	242	3.69	947.56	259.9	3.26	887.79	280.2	2.86	825.91	302.6	2.49
	300	1127.93	276.7	3.59	1061.13	296.6	3.18	992.22	319.2	2.79	919.43	344.2	2.42
	350	1354.71	325.7	3.67	1277.01	349.6	3.25	1196.85	376.6	2.86	1112.46	406.6	2.48
9	140	597.02	141.4	3.73	561.51	151.5	3.31	524.94	162.8	2.9	487.32	175.5	2.52
	155	655.73	153.4	3.78	617.41	164.5	3.35	578.38	177	2.94	537.6	191	2.56
	170	718.32	165.8	3.83	676.83	178	3.4	634.29	191.6	2.98	590.69	206.8	2.6
	185	770.71	187.4	3.69	727.11	200.4	3.28	681.75	214.9	2.89	634.29	231.2	2.52
	200	844.19	208.8	3.62	796.73	222.5	3.23	747.5	238.1	2.85	694.06	255.5	2.49
	250	958.46	226	3.78	902.56	242.1	3.35	845.25	260.1	2.94	784.77	280.2	2.56
	275	1074.84	250.9	3.82	1013.31	268.9	3.39	950.37	289.2	2.98	884.98	311.8	2.59
	300	1205.64	286.9	3.72	1135.32	307	3.3	1062.54	329.6	2.9	985.18	354.7	2.52
	350	1446.48	337.6	3.8	1364.56	361.7	3.37	1280.18	388.8	2.97	1190.87	418.9	2.59

1. Ratings based on TOPSS version 140: evaporator fouling factor of 0.01761m²°C/kW, evaporator temperature drop of 5°C, and 2 pass evaporator configuration. Consult Trane representative for additional performance information.

2. kW input is for compressors only.

3. COP = Coefficient of Performance. Power inputs include compressors and control power.

4. Interpolation between points is permissible. Extrapolation is not permitted.

Controls

LCD Touch Screen Display

The standard DynaView display provided with the Trane CH530 control panel features an LCD touch screen that is navigated by file tabs. This is an advanced interface that allows the user to access any important information concerning setpoints, active temperatures, modes, electrical data, pressure, and diagnostics. It uses full text display available in 19 languages.

Display Features Include:

- LCD touch screen with LED backlighting, for scrolling access to input and output operating information
- Single screen, folder/tab style display of all available information on individual components (evaporator, condenser, compressor, etc.)
- Password entry/lockout system to enable or disable display
- Automatic and immediate stop capabilities for standard or immediate manual shutdown
- Fast, easy access to available chiller data in tabbed format, including:
 - Modes of operation, including normal cooling as well as ice making
 - Water temperatures and setpoints
 - Loading and limiting status and setpoints
 - Outdoor air temperature
 - Start/stop differential timers
 - Pump status and override
 - Chilled water reset settings
- Optional external setpoints, including:
 - Chilled water, demand limit, ice building

Reports, listed on a single tabbed screen for easy access, including:

- ASHRAE, containing all guideline 3 report information
- Evaporator, condenser, compressor

Evaporator, condenser, and compressor reports containing all operational information on individual components, including:

- Water temperatures, refrigerant pressures, temperatures, and approach
- Flow switch status, EXV position, compressor starts and run time

Alarm and diagnostic information, including:

- Flashing alarms with touch screen button for immediate address of alarm condition
- Scrollable list of last ten active diagnostics
- Specific information on applicable diagnostic from list of over one hundred
- Automatic or manual resetting diagnostic types

Adaptive Controls

Adaptive Controls directly sense the control variables that govern the operation of the chiller: evaporator pressure and condenser pressure. When any one of these variables approaches a limit condition when damage may occur to the unit or shutdown on a safety, Adaptive Controls takes corrective action to avoid shutdown and keep the chiller operating. This happens through combined actions of compressor and/or fan staging. Whenever possible, the chiller is allowed to continue making chilled water. This keeps cooling capacity available until the problem can be solved. Overall, the safety controls help keep the building or process running and out of trouble.

Stand Alone Controls

Single chillers installed in applications without a building management system is simple to install and control: only a remote auto/stop for scheduling is required for unit operation. Signals from the chilled water pump contactor auxiliary, or a flow switch, are wired to the chilled water flow interlock. Signals from a time clock or some other remote device are wired to the external auto/stop input.

- External Auto/Stop - A job site provided contact closure will turn the unit on and off.
- Chilled Water Flow Interlock - A job site provided contact closure from a chilled water pump contactor or a flow switch is required and will allow unit operation if a load exists. This feature will allow the unit to run in conjunction with the pump system.
- External Interlock - A job site supplied contact opening wired to this input will turn the unit off and require a manual reset of the unit microcomputer. This closure is typically triggered by a job site supplied system such as a fire alarm.
- Chilled Water Pump Control - Unit controls provide an output to control the chilled water pump(s). One contact closure to the chiller is all that is required to initiate the chilled water system. Chilled water pump control by the chiller is a requirement on the Air-Cooled Series R.
- Chilled Water Temperature Reset - The reset can be based on return water temperature or outdoor air temperature.

Hardwire Points

Microcomputer controls allow simple interface with other control systems, such as time clocks, building automation systems, and ice storage systems via hardwire points. This means you have the flexibility to meet job requirements while not having to learn a complicated control system.

Remote devices are wired from the control panel to provide auxiliary control to a building automation system. Inputs and outputs can be communicated via a typical 4–20 mA electrical signal, an equivalent 2–10 Vdc signal, or by utilizing contact closures. Contact closures may be used to trigger job site supplied alarm lights or alarm bells.

This setup has the same features as a stand alone water chiller, with the possibility of having additional optional features:

- Circuit enable/disable
- Ice making enable/status
- External chilled water setpoint, external demand limit setpoint
- Alarm indication contacts provides three single pole double throw contact closures to indicate: compressor on/off status, compressor running at maximum capacity, failure has occurred (ckt 1/ckt 2)

LonTalk LCI-C Interface

LonTalk (LCI-C) communications capabilities are available, with communication link via single twisted pair wiring to factory installed, tested communication board.

- Required features: LonTalk/Tracer Summit Interface (selectable option with chiller)

LonTalk is a communications protocol developed by the Echelon Corporation. The LonMark association develops control profiles using the LonTalk communication protocol. LonTalk is a unit level communications protocol.

LonTalk Communications Interface for Chillers (LCI-C) provides a generic automation system with the LonMark chiller profile inputs/outputs. In addition to the standard points, Trane provides other commonly used network output variables for greater interoperability with any automation system. The complete reference list of Trane LonTalk points is available on the LonMark web site.

Trane controls or another vendor's system can use the predefined list of points with ease to give the operator a complete picture of how the system is running

Tracer Summit

The chiller plant control capabilities of the Trane Tracer Summit building automation system are unequaled in the industry. Trane's depth of experience in chillers and controls makes us a well qualified choice for automation of chiller plants using air-cooled chillers. Our chiller plant automation software is fully pre-engineered and tested.

Required features:

- LonTalk/Tracer Summit Interface (selectable option with chiller)
- Building Control Unit (external device required)

Energy Efficiency

- Sequences starting of chillers to optimize the overall chiller plant energy efficiency
 - Individual chillers operate as base, peak, or swing based on capacity and efficiency
 - Automatically rotates individual chiller operation to equalize runtime and wear between chillers.
 - Evaluates and selects the lowest energy consumption alternative from an overall system perspective.

Easy Operation and Maintenance

- Remote monitoring and control
- Displays both current operation conditions and scheduled automated control actions
- Concise reports assist in planning for preventative maintenance and verifying performance
- Alarm notification and diagnostic messages aid in quick and accurate troubleshooting

Tracer SC

The Tracer SC system controller acts as the central coordinator for all individual equipment devices on a Tracer building automation system. The Tracer SC scans all unit controllers to update information and coordinate building control, including building subsystems such as VAV and chiller water systems. With this system option, the full breadth of Trane's HVAC and controls experience are applied to offer solutions to many facility issues. The LAN allows building operators to manage these varied components as one system from any personal computer with web access. The benefits of this system are:

- Improved usability with automatic data collection, enhanced data logging, easier to create graphics, simpler navigation, pre-programmed scheduling, reporting, and alarm logs.
- Flexible technology allows for system sizes from 30-120 unit controllers with any combination of LonTalk or BACnet unit controllers.
- LEED certification through site commissioning report, energy data collection measurement, optimizing energy performance, and maintaining indoor air quality.
- Energy savings programs include: fan pressure optimization, ventilation reset, and chiller plant control (adds and subtracts chillers to meet cooling loads).



Electrical Data

Table 1. Standard efficiency – all ambient options

Unit Size	Rated Voltage ¹	# Power Conn ²	# Comp	# Fan Ckt1/ Ckt2	Fan kW	Fan FLA	VFD Input	Cntrl kVA ³	RLA ⁴ Ckt1/Ckt2	XLRA ⁵ Ckt1/Ckt2	YLRA ⁵ Ckt1/Ckt2	MCA ⁶ Ckt1/ Ckt2	MOP ⁷ Ckt1/ Ckt2
140	200/60/3	1	2	8	1.5	6.5	7.3	0.83	270/270	1845/1845	600/600	665	800
	200/60/3	2	2	4/4	1.5	6.5	7.3	0.83	270/270	1845/1845	600/600	368/364	600/600
	230/60/3	1	2	8	1.5	6.5	7.3	0.83	235/235	1556/1556	506/506	586	800
	230/60/3	2	2	4/4	1.5	6.5	7.3	0.83	235/235	1556/1556	506/506	324/321	500/500
	380/60/3	1	2	8	1.5	3.5	3.7	0.83	142/142	973/973	316/316	350	450
	380/60/3	2	2	4/4	1.5	3.5	3.7	0.83	142/142	973/973	316/316	194/192	300/300
	460/60/3	1	2	8	1.5	3	3.7	0.83	118/118	774/774	252/252	293	400
	460/60/3	2	2	4/4	1.5	3	3.7	0.83	118/118	774/774	252/252	162/160	250/250
	575/60/3	1	2	8	1.5	2.5	3.7	0.83	94/94	631/631	205/205	235	300
	575/60/3	2	2	4/4	1.5	2.5	3.7	0.83	94/94	631/631	205/205	130/129	200/200
155	200/60/3	1	2	9	1.5	6.5	7.3	0.83	320/270	2156/1845	701/600	734	1000
	200/60/3	2	2	5/4	1.5	6.5	7.3	0.83	320/270	2156/1845	701/600	437/364	700/600
	230/60/3	1	2	9	1.5	6.5	7.3	0.83	278/235	1756/1556	571/506	646	800
	230/60/3	2	2	5/4	1.5	6.5	7.3	0.83	278/235	1756/1556	571/506	384/321	600/500
	380/60/3	1	2	9	1.5	3.5	3.7	0.83	168/142	1060/973	345/316	386	500
	380/60/3	2	2	5/4	1.5	3.5	3.7	0.83	168/142	1060/973	345/316	230/192	350/300
	460/60/3	1	2	9	1.5	3	3.7	0.83	139/118	878/774	285/252	322	450
	460/60/3	2	2	5/4	1.5	3	3.7	0.83	139/118	878/774	285/252	191/160	300/250
	575/60/3	1	2	9	1.5	2.5	3.7	0.83	111/94	705/631	229/205	259	350
	575/60/3	2	2	5/4	1.5	2.5	3.7	0.83	111/94	705/631	229/205	154/129	250/200
170	200/60/3	1	2	10	1.5	6.5	7.3	0.83	320/320	2156/2156	701/701	791	1000
	200/60/3	2	2	5/5	1.5	6.5	7.3	0.83	320/320	2156/2156	701/701	437/433	700/700
	230/60/3	1	2	10	1.5	6.5	7.3	0.83	278/278	1756/1756	571/571	696	800
	230/60/3	2	2	5/5	1.5	6.5	7.3	0.83	278/278	1756/1756	571/571	384/381	600/600
	380/60/3	1	2	10	1.5	3.5	3.7	0.83	168/168	1060/1060	345/345	416	500
	380/60/3	2	2	5/5	1.5	3.5	3.7	0.83	168/168	1060/1060	345/345	230/228	350/350
	460/60/3	1	2	10	1.5	3	3.7	0.83	139/139	878/878	285/285	346	450
	460/60/3	2	2	5/5	1.5	3	3.7	0.83	139/139	878/878	285/285	191/189	300/300
	575/60/3	1	2	10	1.5	2.5	3.7	0.83	111/111	705/705	229/229	279	350
	575/60/3	2	2	5/5	1.5	2.5	3.7	0.83	111/111	705/705	229/229	154/152	250/250
185	200/60/3	1	2	11	1.5	6.5	7.3	0.83	386/320	2525/2156	821/701	880	1200
	200/60/3	2	2	6/5	1.5	6.5	7.3	0.83	386/320	2525/2156	821/701	526/433	800/700
	230/60/3	1	2	11	1.5	6.5	7.3	0.83	336/278	2126/1756	691/571	775	1000
	230/60/3	2	2	6/5	1.5	6.5	7.3	0.83	336/278	2126/1756	691/571	463/381	700/600
	380/60/3	1	2	11	1.5	3.5	3.7	0.83	203/168	1306/1060	424/345	463	600
	380/60/3	2	2	6/5	1.5	3.5	3.7	0.83	203/168	1306/1060	424/345	277/228	450/350
	460/60/3	1	2	11	1.5	3	3.7	0.83	168/139	1065/878	346/285	385	500
	460/60/3	2	2	6/5	1.5	3	3.7	0.83	168/139	1065/878	346/285	230/189	350/300
	575/60/3	1	2	11	1.5	2.5	3.7	0.83	134/111	853/705	277/229	310	400
	575/60/3	2	2	6/5	1.5	2.5	3.7	0.83	134/111	853/705	277/229	185/152	300/250

Electrical Data

Table 1. Standard efficiency – all ambient options (continued)

Unit Size	Rated Voltage ¹	# Power Conn ²	# Comp	# Fan Ckt1/ Ckt2	Fan kW	Fan FLA	VFD Input	Cntrl kVA ³	RLA ⁴ Ckt1/Ckt2	XLRA ⁵ Ckt1/Ckt2	YLRA ⁵ Ckt1/Ckt2	MCA ⁶ Ckt1/ Ckt2	MOP ⁷ Ckt1/ Ckt2
200	200/60/3	1	2	12	1.5	6.5	7.3	0.83	386/386	2525/2525	821/821	952	1200
	200/60/3	2	2	6/6	1.5	6.5	7.3	0.83	386/386	2525/2525	821/821	526/522	800/800
	230/60/3	1	2	12	1.5	6.5	7.3	0.83	336/336	2126/2126	691/691	839	1000
	230/60/3	2	2	6/6	1.5	6.5	7.3	0.83	336/336	2126/2126	691/691	463/460	700/700
	380/60/3	1	2	12	1.5	3.5	3.7	0.83	203/203	1306/1306	424/424	501	700
	380/60/3	2	2	6/6	1.5	3.5	3.7	0.83	203/203	1306/1306	424/424	277/275	450/450
	460/60/3	1	2	12	1.5	3	3.7	0.83	168/168	1065/1065	346/346	417	500
	460/60/3	2	2	6/6	1.5	3	3.7	0.83	168/168	1065/1065	346/346	230/229	350/350
	575/60/3	1	2	12	1.5	2.5	3.7	0.83	134/134	853/853	277/277	335	450
	575/60/3	2	2	6/6	1.5	2.5	3.7	0.83	134/134	853/853	277/277	185/184	300/300
225	200/60/3	1	2	13	1.5	6.5	7.3	0.83	459/386	2525/2525	821/821	1050	1200
	200/60/3	2	2	7/6	1.5	6.5	7.3	0.83	459/386	2525/2525	821/821	624/522	1000/800
	230/60/3	1	2	13	1.5	6.5	7.3	0.83	399/336	2126/2126	691/691	924	1200
	230/60/3	2	2	7/6	1.5	6.5	7.3	0.83	399/336	2126/2126	691/691	549/460	800/700
	380/60/3	1	2	13	1.5	3.5	3.7	0.83	242/203	1306/1306	424/424	554	700
	380/60/3	2	2	7/6	1.5	3.5	3.7	0.83	242/203	1306/1306	424/424	329/275	500/450
	460/60/3	1	2	13	1.5	3	3.7	0.83	200/168	1065/1065	346/346	460	600
	460/60/3	2	2	7/6	1.5	3	3.7	0.83	200/168	1065/1065	346/346	273/229	450/350
	575/60/3	1	2	13	1.5	2.5	3.7	0.83	160/134	853/853	277/277	370	500
	575/60/3	2	2	7/6	1.5	2.5	3.7	0.83	160/134	853/853	277/277	220/184	350/300
250	200/60/3	1	2	14	1.5	6.5	7.3	0.83	459/459	2525/2525	821/821	1129	1200
	200/60/3	2	2	7/7	1.5	6.5	7.3	0.83	459/459	2525/2525	821/821	624/620	1000/1000
	230/60/3	1	2	14	1.5	6.5	7.3	0.83	399/399	2126/2126	691/691	994	1200
	230/60/3	2	2	7/7	1.5	6.5	7.3	0.83	399/399	2126/2126	691/691	549/545	800/800
	380/60/3	1	2	14	1.5	3.5	3.7	0.83	242/242	1306/1306	424/424	596	800
	380/60/3	2	2	7/7	1.5	3.5	3.7	0.83	242/242	1306/1306	424/424	329/327	500/500
	460/60/3	1	2	14	1.5	3	3.7	0.83	200/200	1065/1065	346/346	495	600
	460/60/3	2	2	7/7	1.5	3	3.7	0.83	200/200	1065/1065	346/346	273/272	450/450
	575/60/3	1	2	14	1.5	2.5	3.7	0.83	160/160	853/853	277/277	399	500
	575/60/3	2	2	7/7	1.5	2.5	3.7	0.83	160/160	853/853	277/277	220/220	350/350
275	200/60/3	1							n/a				
	200/60/3	2	3	10/6	1.5	6.5	7.3	1.2	320-320/386	2156-2156/2525	701-701/821	791/526	1000/800
	230/60/3	1							n/a				
	230/60/3	2	3	10/6	1.5	6.5	7.3	1.2	278-278/336	1756-1756/2126	571-571/691	696/463	800/700
	380/60/3	1							n/a				
	380/60/3	2	3	10/6	1.5	3.5	3.7	1.2	168-168/203	1060-1060/1306	345-345/424	417/277	500/450
	460/60/3	1	3	16	1.5	3	3.7	1.2	139-139/168	878-878/1065	285-285/346	542	700
	460/60/3	2	3	10/6	1.5	3	3.7	1.2	139-139/168	878-878/1065	285-285/346	346/231	450/350
	575/60/3	1	3	16	1.5	2.5	3.7	1.2	111-111/134	705-705/853	229-229/277	436	500
	575/60/3	2	3	10/6	1.5	2.5	3.7	1.2	111-111/134	705-705/853	229-229/277	279/185	350/300



Electrical Data

Table 1. Standard efficiency – all ambient options (continued)

Unit Size	Rated Voltage ¹	# Power Conn ²	# Comp	# Fan Ckt1/Ckt2	Fan kW	Fan FLA	VFD Input	Cntrl kVA ³	RLA ⁴ Ckt1/Ckt2	XLRA ⁵ Ckt1/Ckt2	YLRA ⁵ Ckt1/Ckt2	MCA ⁶ Ckt1/Ckt2	MOP ⁷ Ckt1/Ckt2
300	200/60/3	1							n/a				
	200/60/3	2	3	12/6	1.5	6.5	7.3	1.2	386-386/386	2525-2525/2525	821-821/821	925/526	1200/800
	230/60/3	1							n/a				
	230/60/3	2	3	12/6	1.5	6.5	7.3	1.2	336-336/336	2126-2126/2126	691-691/691	839/463	1000/700
	380/60/3	1							n/a				
	380/60/3	2	3	12/6	1.5	3.5	3.7	1.2	203-203/203	1306-1306/1306	424-424/424	501/277	700/450
	460/60/3	1	3	18	1.5	3	3.7	1.2	168-168/168	1065-1065/1065	346-346/346	606	700
	460/60/3	2	3	12/6	1.5	3	3.7	1.2	168-168/168	1065-1065/1065	346-346/346	417/231	500/350
	575/60/3	1	3	18	1.5	2.5	3.7	1.2	134-134/134	853-853/853	277-277/277	487	600
	575/60/3	2	3	12/6	1.5	2.5	3.7	1.2	134-134/134	853-853/853	277-277/277	335/185	450/300
350	200/60/3	1							n/a				
	200/60/3	2	3	14/6	1.5	6.5	7.3	1.2	459-459/386	2525-2525/2525	821-821/821	1130/526	1200/800
	230/60/3	1							n/a				
	230/60/3	2	3	14/6	1.5	6.5	7.3	1.2	399-399/336	2126-2126/2126	691-691/691	994/463	1200/700
	380/60/3	1							n/a				
	380/60/3	2	3	14/6	1.5	3.5	3.7	1.2	242-242/203	1306-1306/1306	424-424/424	596/277	800/450
	460/60/3	1	3	20	1.5	3	3.7	1.2	200-200/168	1065-1065/1065	346-346/346	684	800
	460/60/3	2	3	14/6	1.5	3	3.7	1.2	200-200/168	1065-1065/1065	346-346/346	495/231	600/350
	575/60/3	1	3	20	1.5	2.5	3.7	1.2	160-160/134	853-853/853	277-277/277	551	700
	575/60/3	2	3	14/6	1.5	2.5	3.7	1.2	160-160/134	853-853/853	277-277/277	399/185	500/300
400	200/60/3	1							n/a				
	200/60/3	2	4	12/12	1.5	6.5	7.3	1.59	386-386/386-386	2525-2525/2525-2525	821-821/821-821	952/952	1200/1200
	230/60/3	1							n/a				
	230/60/3	2	4	12/12	1.5	6.5	7.3	1.59	336-336/336-336	2126-2126/2126-2126	691-691/691-691	839/839	1000/1000
	380/60/3	1							n/a				
	380/60/3	2	4	12/12	1.5	3.5	3.7	1.59	203-203/203-203	1306-1306/1306-1306	424-424/424-424	501/501	700/700
	460/60/3	1	4	24	1.5	3	3.7	1.59	168-168/168-168	1065-1065/1065-1065	346-346/346-346	792	800
	460/60/3	2	4	12/12	1.5	3	3.7	1.59	168-168/168-168	1065-1065/1065-1065	346-346/346-346	417/417	500/500
	575/60/3	1	4	24	1.5	2.5	3.7	1.59	134-134/134-134	853-853/853-853	277-277/277-277	637	700
	575/60/3	2	4	12/12	1.5	2.5	3.7	1.59	134-134/134-134	853-853/853-853	277-277/277-277	335/335	450/450
450	200/60/3	1							n/a				
	200/60/3	2	4	14/12	1.5	6.5	7.3	1.59	459-459/386-386	2525-2525/2525-2525	821-821/821-821	1130/952	1200/1200
	230/60/3	1							n/a				
	230/60/3	2	4	14/12	1.5	6.5	7.3	1.59	399-399/336-336	2126-2126/2126-2126	691-691/691-691	994/839	1200/1000
	380/60/3	1							n/a				
	380/60/3	2	4	14/12	1.5	3.5	3.7	1.59	242-242/203-203	1306-1306/1306-1306	424-424/424-424	596/501	800/700
	460/60/3	1	4	26	1.5	3	3.7	1.59	200-200/168-168	1065-1065/1065-1065	346-346/346-346	870	1000
	460/60/3	2	4	14/12	1.5	3	3.7	1.59	200-200/168-168	1065-1065/1065-1065	346-346/346-346	495/417	600/500
	575/60/3	1	4	26	1.5	2.5	3.7	1.59	160-160/134-134	853-853/853-853	277-277/277-277	701	800
	575/60/3	2	4	14/12	1.5	2.5	3.7	1.59	160-160/134-134	853-853/853-853	277-277/277-277	399/335	500/450

Electrical Data

Table 1. Standard efficiency – all ambient options (continued)

Unit Size	Rated Voltage ¹	# Power Conn ²	# Comp	# Fan			VFD Input	Cntrl kVA ³	RLA ⁴ Ckt1/Ckt2	XLRA ⁵ Ckt1/Ckt2	YLRA ⁵ Ckt1/Ckt2	MCA ⁶ Ckt1/Ckt2	MOP ⁷ Ckt1/Ckt2
				Ckt1/Ckt2	Fan kW	Fan FLA							
	200/60/3	1							n/a				
	200/60/3	2	4	14/14	1.5	6.5	7.3	1.59	459-459/ 459-459	2525-2525/2525- 2525	821-821/ 821-821	1130/ 1130	1200/ 1200
	230/60/3	1							n/a				
	230/60/3	2	4	14/14	1.5	6.5	7.3	1.59	399-399/ 399-399	2126-2126/2126- 2126	691-691/ 691-691	994/994	1200/ 1200
	380/60/3	1							n/a				
500	380/60/3	2	4	14/14	1.5	3.5	3.7	1.59	242-242/242-242	1306-1306/1306- 1306	424-424/424-424	596/596	800/800
	460/60/3	1	4	28	1.5	3	3.7	1.59	200-200/200-200	1065-1065/1065- 1065	346-346/346-346	940	1000
	460/60/3	2	4	14/14	1.5	3	3.7	1.59	200-200/200-200	1065-1065/1065- 1065	346-346/346-346	495/495	600/600
	575/60/3	1	4	28	1.5	2.5	3.7	1.59	160-160/160-160	853-853/853-853	277-277/277-277	758	800
	575/60/3	2	4	14/14	1.5	2.5	3.7	1.59	160-160/160-160	853-853/853-853	277-277/277-277	399/399	500/500

Notes:

1. Voltage Utilization Range: +/- 10% of rated voltage. Rated voltage (use range): 200/60/3 (180-220), 230/60/3 (208-254), 380/60/3 (342-418), 460/60/3 (414-506), 575/60/3 (516-633)
2. As standard, 140-250 ton units have a single point power connection. Optional dual point power connections are available. As standard, 275-500 ton units have dual point power connections. Optional single point power connections are available on 460V and 575V/60 Hz units.
3. Control VA includes operational controls only. It does not include evaporator heaters. A separate 115/60/1, 20 amp customer provided power connection is required to power the evaporator heaters (1640 watts).
4. RLA - Rated Load Amps
5. XLRA - Locked Rotor Amps - based on full winding (x-line) start units). YLRA for wye-delta starters is ~1/3 of LRA of x-line units.
6. MCA - Minimum Circuit Ampacity - 125 percent of largest compressor RLA plus 100 percent of all other loads.
7. Max fuse or MOPD = 225 percent of the largest compressor RLA plus 100 percent of the second compressor RLA, plus the sum of the condenser fan FLA. (Use FLA per circuit, NOT FLA for the entire unit).
8. Local codes may take precedence.
9. All ambient means standard, low, high and wide ambient options.



Electrical Data

Table 2. High efficiency — standard and low ambient options

Unit Size	Rated Voltage ¹	# Power Conn ²	# Comp	# Fan Ckt1/Ckt2	Fan kW	Fan FLA	VFD Input	Cntrl kVA ³	RLA ⁴ Ckt1/Ckt2	XLRA ⁵ Ckt1/Ckt2	YLRA ⁵ Ckt1/Ckt2	MCA ⁶ Ckt1/Ckt2	MOP ⁷ Ckt1/Ckt2
140	200/60/3	1	2	10	1.5	6.5	7.3	0.83	259/259	1845/1845	600/600	653	800
	200/60/3	2	2	5/5	1.5	6.5	7.3	0.83	259/259	1845/1845	600/600	361/357	600/600
	230/60/3	1	2	10	1.5	6.5	7.3	0.83	225/225	1556/1556	506/506	576	800
	230/60/3	2	2	5/5	1.5	6.5	7.3	0.83	225/225	1556/1556	506/506	318/315	500/500
	380/60/3	1	2	10	1.5	3.5	3.7	0.83	136/136	973/973	316/316	344	450
	380/60/3	2	2	5/5	1.5	3.5	3.7	0.83	136/136	973/973	316/316	190/188	300/300
	460/60/3	1	2	10	1.5	3	3.7	0.83	113/113	774/774	252/252	287	400
	460/60/3	2	2	5/5	1.5	3	3.7	0.83	113/113	774/774	252/252	159/157	250/250
	575/60/3	1	2	10	1.5	2.5	3.7	0.83	90/90	631/631	205/205	231	300
	575/60/3	2	2	5/5	1.5	2.5	3.7	0.83	90/90	631/631	205/205	128/126	200/200
155	200/60/3	1	2	11	1.5	6.5	7.3	0.83	305/259	2156/1845	701/600	717	1000
	200/60/3	2	2	6/5	1.5	6.5	7.3	0.83	305/259	2156/1845	701/600	425/357	700/600
	230/60/3	1	2	11	1.5	6.5	7.3	0.83	265/225	1756/1556	571/506	633	800
	230/60/3	2	2	6/5	1.5	6.5	7.3	0.83	265/225	1756/1556	571/506	375/315	600/500
	380/60/3	1	2	11	1.5	3.5	3.7	0.83	161/136	1060/973	345/316	378	500
	380/60/3	2	2	6/5	1.5	3.5	3.7	0.83	161/136	1060/973	345/316	225/188	350/300
	460/60/3	1	2	11	1.5	3	3.7	0.83	133/113	878/774	285/252	315	400
	460/60/3	2	2	6/5	1.5	3	3.7	0.83	133/113	878/774	285/252	187/157	300/250
	575/60/3	1	2	11	1.5	2.5	3.7	0.83	106/90	705/631	229/205	254	350
	575/60/3	2	2	6/5	1.5	2.5	3.7	0.83	106/90	705/631	229/205	150/126	250/200
170	200/60/3	1	2	12	1.5	6.5	7.3	0.83	305/305	2156/2156	701/701	770	1000
	200/60/3	2	2	12/12	1.5	6.5	7.3	0.83	305/305	2156/2156	701/701	425/421	700/700
	230/60/3	1	2	12	1.5	6.5	7.3	0.83	265/265	1756/1756	571/571	679	800
	230/60/3	2	2	12/12	1.5	6.5	7.3	0.83	265/265	1756/1756	571/571	375/371	600/600
	380/60/3	1	2	12	1.5	3.5	3.7	0.83	161/161	1060/1060	345/345	407	500
	380/60/3	2	2	12/12	1.5	3.5	3.7	0.83	161/161	1060/1060	345/345	225/222	350/350
	460/60/3	1	2	12	1.5	3	3.7	0.83	133/133	878/878	285/285	338	450
	460/60/3	2	2	12/12	1.5	3	3.7	0.83	133/133	878/878	285/285	187/185	300/300
	575/60/3	1	2	12	1.5	2.5	3.7	0.83	106/106	705/705	229/229	272	350
	575/60/3	2	2	12/12	1.5	2.5	3.7	0.83	106/106	705/705	229/229	150/149	250/250
185	200/60/3	1	2	13	1.5	6.5	7.3	0.83	373-305	2525/2156	821/701	861	1200
	200/60/3	2	2	7/6	1.5	6.5	7.3	0.83	373/305	2525/2156	821/701	517/421	800/700
	230/60/3	1	2	13	1.5	6.5	7.3	0.83	324-265	2126/1756	691/571	760	1000
	230/60/3	2	2	7/6	1.5	6.5	7.3	0.83	324/265	2126/1756	691/571	455/371	700/600
	380/60/3	1	2	13	1.5	3.5	3.7	0.83	196-161	1306/1060	424/345	454	600
	380/60/3	2	2	7/6	1.5	3.5	3.7	0.83	196/161	1306/1060	424/345	272/222	450/350
	460/60/3	1	2	13	1.5	3	3.7	0.83	162-133	1065/878	346/285	378	500
	460/60/3	2	2	7/6	1.5	3	3.7	0.83	162/133	1065/878	346/285	226/185	350/300
	575/60/3	1	2	13	1.5	2.5	3.7	0.83	130-106	853/705	277/229	305	400
	575/60/3	2	2	7/6	1.5	2.5	3.7	0.83	130/106	853/705	277/229	183/149	300/250

Electrical Data

Table 2. High efficiency — standard and low ambient options (continued)

Unit Size	Rated Voltage ¹	# Power Conn ²	# Comp	# Fan Ckt1/Ckt2	Fan kW	Fan FLA	VFD Input	Cntrl kVA ³	RLA ⁴ Ckt1/Ckt2	XLRA ⁵ Ckt1/Ckt2	YLRA ⁵ Ckt1/Ckt2	MCA ⁶ Ckt1/Ckt2	MOP ⁷ Ckt1/Ckt2
200	200/60/3	1	2	14	1.5	6.5	7.3	0.83	373/373	2525/2525	821/821	936	1200
	200/60/3	2	2	7/7	1.5	6.5	7.3	0.83	373/373	2525/2525	821/821	517/513	800/800
	230/60/3	1	2	14	1.5	6.5	7.3	0.83	324/324	2126/2126	691/691	825	1000
	230/60/3	2	2	7/7	1.5	6.5	7.3	0.83	324/324	2126/2126	691/691	455/451	700/700
	380/60/3	1	2	14	1.5	3.5	3.7	0.83	196/196	1306/1306	424/424	493	600
	380/60/3	2	2	7/7	1.5	3.5	3.7	0.83	196/196	1306/1306	424/424	272/270	450/450
	460/60/3	1	2	14	1.5	3	3.7	0.83	162/162	1065/1065	346/346	410	500
	460/60/3	2	2	7/7	1.5	3	3.7	0.83	162/162	1065/1065	346/346	226/224	350/350
	575/60/3	1	2	14	1.5	2.5	3.7	0.83	130/130	853/853	277/277	331	450
	575/60/3	2	2	7/7	1.5	2.5	3.7	0.83	130/130	853/853	277/277	183/181	300/300
225	200/60/3	1	2	14	1.5	6.5	7.3	0.83	447/373	2525/2525	821/821	1028	1200
	200/60/3	2	2	8/6	1.5	6.5	7.3	0.83	447/373	2525/2525	821/821	616/506	1000/800
	230/60/3	1	2	14	1.5	6.5	7.3	0.83	388/324	2126/2126	691/691	905	1200
	230/60/3	2	2	8/6	1.5	6.5	7.3	0.83	388/324	2126/2126	691/691	541/445	800/700
	380/60/3	1	2	14	1.5	3.5	3.7	0.83	235/196	1306/1306	424/424	541	700
	380/60/3	2	2	8/6	1.5	3.5	3.7	0.83	235/196	1306/1306	424/424	324/266	500/450
	460/60/3	1	2	14	1.5	3	3.7	0.83	194/162	1065/1065	346/346	450	600
	460/60/3	2	2	8/6	1.5	3	3.7	0.83	194/162	1065/1065	346/346	269/221	450/350
	575/60/3	1	2	14	1.5	2.5	3.7	0.83	155/130	853/853	277/277	363	500
	575/60/3	2	2	8/6	1.5	2.5	3.7	0.83	155/130	853/853	277/277	216/179	350/300
250	200/60/3	1	2	16	1.5	6.5	7.3	0.83	447/447	2525/2525	821/821	1115	1200
	200/60/3	2	2	8/8	1.5	6.5	7.3	0.83	447/447	2525/2525	821/821	616/612	1000/1000
	230/60/3	1	2	16	1.5	6.5	7.3	0.83	388/388	2126/2126	691/691	982	1200
	230/60/3	2	2	8/8	1.5	6.5	7.3	0.83	388/388	2126/2126	691/691	541/538	800/800
	380/60/3	1	2	16	1.5	3.5	3.7	0.83	235/235	1306/1306	424/424	587	800
	380/60/3	2	2	8/8	1.5	3.5	3.7	0.83	235/235	1306/1306	424/424	324/322	500/500
	460/60/3	1	2	16	1.5	3	3.7	0.83	194/194	1065/1065	346/346	488	600
	460/60/3	2	2	8/8	1.5	3	3.7	0.83	194/194	1065/1065	346/346	269/267	450/450
	575/60/3	1	2	7/4	1.5	2.5	3.7	0.83	155/155	853/853	277/277	393	500
	575/60/3	2	2	8/8	1.5	2.5	3.7	0.83	155/155	853/853	277/277	216/215	350/350
275	200/60/3	1							n/a				
	200/60/3	2	3	12/6	1.5	6.5	7.3	1.2	305-305/373	2156-2156/2525	701-701/821	770/510	1000/800
	230/60/3	1							n/a				
	230/60/3	2	3	12/6	1.5	6.5	7.3	1.2	265-265/324	1756-1756/2126	571-571/691	679/448	800/700
	380/60/3	1							n/a				
	380/60/3	2	3	12/6	1.5	3.5	3.7	1.2	161-161/196	1060-1060/1306	345-345/424	407/268	500/450
	460/60/3	1	3	18	1.5	3	3.7	1.2	133-133/162	878-878/1065	285-285/346	528	600
	460/60/3	2	3	12/6	1.5	3	3.7	1.2	133-133/162	878-878/1065	285-285/346	338/223	450/350
	575/60/3	1	3	18	1.5	2.5	3.7	1.2	106-106/130	705-705/853	229-229/277	426	500
	575/60/3	2	3	12/6	1.5	2.5	3.7	1.2	106-106/130	705-705/853	229-229/277	272/180	350/300



Electrical Data

Table 2. High efficiency — standard and low ambient options (continued)

Unit Size	Rated Voltage ¹	# Power Conn ²	# Comp	# Fan Ckt1/Ckt2	Fan kW	Fan FLA	VFD Input	Cntrl kVA ³	RLA ⁴ Ckt1/Ckt2	XLRA ⁵ Ckt1/Ckt2	YLRA ⁵ Ckt1/Ckt2	MCA ⁶ Ckt1/Ckt2	MOP ⁷ Ckt1/Ckt2
300	200/60/3	1							n/a				
	200/60/3	2	3	14/6	1.5	6.5	7.3	1.2	373-373/373	2525-2525/2525	821-821/821	936/510	1200/800
	230/60/3	1							n/a				
	230/60/3	2	3	14/6	1.5	6.5	7.3	1.2	324-324/324	2126-2126/2126	691-691/691	825/448	1000/700
	380/60/3	1							n/a				
	380/60/3	2	3	14/6	1.5	3.5	3.7	1.2	196-196/196	1306-1306/1306	424-424/424	493/268	600/450
	460/60/3	1	3	20	1.5	3	3.7	1.2	162-162/162	1065-1065/1065	346-346/346	592	700
	460/60/3	2	3	14/6	1.5	3	3.7	1.2	162-162/162	1065-1065/1065	346-346/346	410/223	500/350
	575/60/3	1	3	20	1.5	2.5	3.7	1.2	130-130/130	853-853/853	277-277/277	479	600
	575/60/3	2	3	14/6	1.5	2.5	3.7	1.2	130-130/130	853-853/853	277-277/277	331/180	450/300
350	200/60/3	1							n/a				
	200/60/3	2	4	12/12	1.5	6.5	7.3	1.2	305-305/305-305	2156-2156/2156-2156	701-701/701-701	770/770	1000/1000
	230/60/3	1							n/a				
	230/60/3	2	4	12/12	1.5	6.5	7.3	1.2	265-265/265-265	1756-1756/1756-1756	571-571/571-571	679/679	800/800
	380/60/3	1							n/a				
	380/60/3	2	4	14/6	1.5	3.5	3.7	1.2	196-196/196-196	1306-1306/1306-1306	424-424/424-424	493/268	600/450
	460/60/3	1	4	20	1.5	3	3.7	1.2	162-162/162-162	1065-1065/1065-1065	346-346/346-346	592	700
	460/60/3	2	4	14/6	1.5	3	3.7	1.2	162-162/162-162	1065-1065/1065-1065	346-346/346-346	410/223	500/350
	575/60/3	1	4	20	1.5	2.5	3.7	1.2	130-130/130-130	853-853/853-853	277-277/277-277	479	600
	575/60/3	2	4	14/6	1.5	2.5	3.7	1.2	130-130/130-130	853-853/853-853	277-277/277-277	331/180	450/300
400	200/60/3	1							n/a				
	200/60/3	2	4	14/14	1.5	6.5	7.3	1.59	373-373/373-373	2525-2525/2525-2525	821-821/821-821	936/936	1200/1200
	230/60/3	1							n/a				
	230/60/3	2	4	14/14	1.5	6.5	7.3	1.59	324-324/324-324	2126-2126/2126-2126	691-691/691-691	825/825	1000/1000
	380/60/3	1							n/a				
	380/60/3	2	4	14/14	1.5	3.5	3.7	1.59	196-196/196-196	1306-1306/1306-1306	424-424/424-424	493/493	600/600
	460/60/3	1	4	28	1.5	3	3.7	1.59	162-162/162-162	1065-1065/1065-1065	346-346/346-346	779	900
	460/60/3	2	4	14/14	1.5	3	3.7	1.59	162-162/162-162	1065-1065/1065-1065	346-346/346-346	410/410	500/500
	575/60/3	1	4	28	1.5	2.5	3.7	1.59	130-130/130-130	853-853/853-853	277-277/277-277	630	700
	575/60/3	2	4	14/14	1.5	2.5	3.7	1.59	130-130/130-130	853-853/853-853	277-277/277-277	331/331	450/450

Notes:

1. Voltage Utilization Range: +/- 10% of rated voltage. Rated voltage (use range): 200/60/3 (180-220), 230/60/3 (208-254), 380/60/3 (342-418), 460/60/3 (414-506), 575/60/3 (516-633)
2. As standard, 140-250 ton units have a single point power connection. Optional dual point power connections are available. As standard, 275-500 ton units have dual point power connections. Optional single point power connections are available on 460V and 575V/60 Hz units.
3. Control VA includes operational controls only. It does not include evaporator heaters. A separate 115/60/1, 20 amp customer provided power connection is required to power the evaporator heaters (1640 watts).
4. RLA - Rated Load Amps
5. XLRA - Locked Rotor Amps - based on full winding (x-line) start units). YLRA for wye-delta starters is ~1/3 of LRA of x-line units.
6. MCA - Minimum Circuit Ampacity - 125 percent of largest compressor RLA plus 100 percent of all other loads.
7. Max fuse or MOPD = 225 percent of the largest compressor RLA plus 100 percent of the second compressor RLA, plus the sum of the condenser fan FLA. (Use FLA per circuit, NOT FLA for the entire unit).
8. Local codes may take precedence.
9. All ambient means standard, low, high and wide ambient options.

Table 3. High efficiency — high and wide ambient options

Unit Size	Rated Voltage ¹	# Power Conn ²	# Comp	# Fan Ckt1/Ckt2	Fan kW	Fan FLA	VFD Input	Cntrl kVA ³	RLA ⁴ Ckt1/Ckt2	XLRA ⁵ Ckt1/Ckt2	YLRA ⁵ Ckt1/Ckt2	MCA ⁶ Ckt1/Ckt2	MOP ⁷ Ckt1/Ckt2
140	200/60/3	1	2	10	1.5	6.5	7.3	0.83	270/270	1845/1845	600/600	678	800
	200/60/3	2	2	5/5	1.5	6.5	7.3	0.83	270/270	1845/1845	600/600	375/371	600/600
	230/60/3	1	2	10	1.5	6.5	7.3	0.83	235/235	1556/1556	506/506	599	800
	230/60/3	2	2	5/5	1.5	6.5	7.3	0.83	235/235	1556/1556	506/506	331/327	500/500
	380/60/3	1	2	10	1.5	3.5	3.7	0.83	142/142	973/973	316/316	357	450
	380/60/3	2	2	5/5	1.5	3.5	3.7	0.83	142/142	973/973	316/316	197/195	300/300
	460/60/3	1	2	10	1.5	3	3.7	0.83	118/118	774/774	252/252	299	400
	460/60/3	2	2	5/5	1.5	3	3.7	0.83	118/118	774/774	252/252	165/163	250/250
	575/60/3	1	2	10	1.5	2.5	3.7	0.83	94/94	631/631	205/205	240	300
	575/60/3	2	2	5/5	1.5	2.5	3.7	0.83	94/94	631/631	205/205	133/131	225/225
155	200/60/3	1	2	11	1.5	6.5	7.3	0.83	320/270	2156/1845	701/600	747	1000
	200/60/3	2	2	6/5	1.5	6.5	7.3	0.83	320/270	2156/1845	701/600	444/371	700/600
	230/60/3	1	2	11	1.5	6.5	7.3	0.83	278/235	1756/1556	571/506	659	800
	230/60/3	2	2	6/5	1.5	6.5	7.3	0.83	278/235	1756/1556	571/506	391/327	600/500
	380/60/3	1	2	11	1.5	3.5	3.7	0.83	168/142	1060/973	345/316	393	500
	380/60/3	2	2	6/5	1.5	3.5	3.7	0.83	168/142	1060/973	345/316	233/195	400/300
	460/60/3	1	2	11	1.5	3	3.7	0.83	139/118	878/774	285/252	328	450
	460/60/3	2	2	6/5	1.5	3	3.7	0.83	139/118	878/774	285/252	194/163	300/250
	575/60/3	1	2	11	1.5	2.5	3.7	0.83	111/94	705/631	229/205	264	350
	575/60/3	2	2	6/5	1.5	2.5	3.7	0.83	111/94	705/631	229/205	156/131	250/200
170	200/60/3	1	2	12	1.5	6.5	7.3	0.83	320/320	2156/2156	701/701	804	1000
	200/60/3	2	2	6/6	1.5	6.5	7.3	0.83	320/320	2156/2156	701/701	444/440	700/700
	230/60/3	1	2	12	1.5	6.5	7.3	0.83	278/278	1756/1756	571/571	709	800
	230/60/3	2	2	6/6	1.5	6.5	7.3	0.83	278/278	1756/1756	571/571	391/387	600/600
	380/60/3	1	2	12	1.5	3.5	3.7	0.83	168/168	1060/1060	345/345	423	500
	380/60/3	2	2	6/6	1.5	3.5	3.7	0.83	168/168	1060/1060	345/345	233/231	400/350
	460/60/3	1	2	12	1.5	3	3.7	0.83	139/139	878/878	285/285	352	450
	460/60/3	2	2	6/6	1.5	3	3.7	0.83	139/139	878/878	285/285	194/192	300/300
	575/60/3	1	2	12	1.5	2.5	3.7	0.83	111/111	705/705	229/229	284	350
	575/60/3	2	2	6/6	1.5	2.5	3.7	0.83	111/111	705/705	229/229	156/155	250/250
185	200/60/3	1	2	13	1.5	6.5	7.3	0.83	386/320	2525/2156	821/701	893	1200
	200/60/3	2	2	7/6	1.5	6.5	7.3	0.83	386/320	2525/2156	821/701	533/440	800/700
	230/60/3	1	2	13	1.5	6.5	7.3	0.83	336/278	2126/1756	691-571	788	1000
	230/60/3	2	2	7/6	1.5	6.5	7.3	0.83	336/278	2126/1756	691/571	470/387	800/600
	380/60/3	1	2	13	1.5	3.5	3.7	0.83	203/168	1306/1060	424/345	470	600
	380/60/3	2	2	7/6	1.5	3.5	3.7	0.83	203/168	1306/1060	424/345	281/231	450/350
	460/60/3	1	2	13	1.5	3	3.7	0.83	168/139	1065/878	346/285	391	500
	460/60/3	2	2	7/6	1.5	3	3.7	0.83	168/139	1065/878	346/285	233/192	400/300
	575/60/3	1	2	13	1.5	2.5	3.7	0.83	134/111	853/705	277/229	315	450
	575/60/3	2	2	7/6	1.5	2.5	3.7	0.83	134/111	853/705	277/229	188/155	300/250



Electrical Data

Table 3. High efficiency — high and wide ambient options (continued)

Unit Size	Rated Voltage ¹	# Power Conn ²	# Comp	# Fan Ckt1/Ckt2	Fan kW	Fan FLA	VFD Input	Cntrl kVA ³	RLA ⁴ Ckt1/Ckt2	XLRA ⁵ Ckt1/Ckt2	YLRA ⁵ Ckt1/Ckt2	MCA ⁶ Ckt1/Ckt2	MOP ⁷ Ckt1/Ckt2
200	200/60/3	1	2	14	1.5	6.5	7.3	0.83	386/386	2525/2525	821/821	965	1200
	200/60/3	2	2	7/7	1.5	6.5	7.3	0.83	386/386	2525/2525	821/821	533/529	800/800
	230/60/3	1	2	14	1.5	6.5	7.3	0.83	336/336	2126/2126	691/691	852	1000
	230/60/3	2	2	7/7	1.5	6.5	7.3	0.83	336/336	2126/2126	691/691	470/466	800/800
	380/60/3	1	2	14	1.5	3.5	3.7	0.83	203/203	1306/1306	424/424	508	700
	380/60/3	2	2	7/7	1.5	3.5	3.7	0.83	203/203	1306/1306	424/424	281/278	450/450
	460/60/3	1	2	14	1.5	3	3.7	0.83	168/168	1065/1065	346/346	423	500
	460/60/3	2	2	7/7	1.5	3	3.7	0.83	168/168	1065/1065	346/346	233/232	400/350
	575/60/3	1	2	14	1.5	2.5	3.7	0.83	134/134	853/853	277/277	340	450
	575/60/3	2	2	7/7	1.5	2.5	3.7	0.83	134/134	853/853	277/277	188/186	300/300
225	200/60/3	1	2	14	1.5	6.5	7.3	0.83	459/386	2525/2525	821/821	1056	1200
	200/60/3	2	2	8/6	1.5	6.5	7.3	0.83	459/386	2525/2525	821/821	631/522	1000/800
	230/60/3	1	2	14	1.5	6.5	7.3	0.83	399/336	2126/2126	691/691	931	1200
	230/60/3	2	2	8/6	1.5	6.5	7.3	0.83	399/336	2126/2126	691/691	555/460	800/700
	380/60/3	1	2	14	1.5	3.5	3.7	0.83	242/203	1306/1306	424/424	557	700
	380/60/3	2	2	8/6	1.5	3.5	3.7	0.83	242/203	1306/1306	424/424	333/275	500/450
	460/60/3	1	2	14	1.5	3	3.7	0.83	200/168	1065/1065	346/346	463	600
	460/60/3	2	2	8/6	1.5	3	3.7	0.83	200/168	1065/1065	346/346	276/229	450/350
	575/60/3	1	2	14	1.5	2.5	3.7	0.83	160/134	853/853	277/277	373	500
	575/60/3	2	2	8/6	1.5	2.5	3.7	0.83	160/134	853/853	277/277	223/184	350/300
250	200/60/3	1	2	16	1.5	6.5	7.3	0.83	459/459	2525/2525	821/821	1142	1200
	200/60/3	2	2	8/8	1.5	6.5	7.3	0.83	459/459	2525/2525	821/821	631/627	1000/1000
	230/60/3	1	2	16	1.5	6.5	7.3	0.83	399/399	2126/2126	691/691	1007	1200
	230/60/3	2	2	8/8	1.5	6.5	7.3	0.83	399/399	2126/2126	691/691	555/552	800/800
	380/60/3	1	2	16	1.5	3.5	3.7	0.83	242/242	1306/1306	424/424	603	800
	380/60/3	2	2	8/8	1.5	3.5	3.7	0.83	242/242	1306/1306	424/424	333/331	500/500
	460/60/3	1	2	16	1.5	3	3.7	0.83	200/200	1065/1065	346/346	501	700
	460/60/3	2	2	8/8	1.5	3	3.7	0.83	200/200	1065/1065	346/346	276/275	450/450
	575/60/3	1	2	16	1.5	2.5	3.7	0.83	160/160	853/853	277/277	404	500
	575/60/3	2	2	8/8	1.5	2.5	3.7	0.83	160/160	853/853	277/277	223/221	350/350
275	200/60/3	1							n/a				
	200/60/3	2	3	12/6	1.5	6.5	7.3	1.2	320-320/386	2156-2156/2525	701-701/821	804/526	1000/800
	230/60/3	1							n/a				
	230/60/3	2	3	12/6	1.5	6.5	7.3	1.2	278-278/336	1756-1756/2126	571-571/691	709/463	800/700
	380/60/3	1							n/a				
	380/60/3	2	3	12/6	1.5	3.5	3.7	1.2	168-168/203	1060-1060/1306	345-345/424	423/277	500/450
	460/60/3	1	3	18	1.5	3	3.7	1.2	139-139/168	878-878/1065	285-285/346	548	700
	460/60/3	2	3	12/6	1.5	3	3.7	1.2	139-139/168	878-878/1065	285-285/346	352/231	450/350
	575/60/3	1	3	18	1.5	2.5	3.7	1.2	111-111/134	705-705/853	229-229/277	441	500
	575/60/3	2	3	12/6	1.5	2.5	3.7	1.2	111-111/134	705-705/853	229-229/277	284/185	350/300

Table 3. High efficiency — high and wide ambient options (continued)

Unit Size	Rated Voltage ¹	# Power Conn ²	# Comp	# Fan Ckt1/Ckt2	Fan kW	Fan FLA	VFD Input	Cntrl kVA ³	RLA ⁴ Ckt1/Ckt2	XLRA ⁵ Ckt1/Ckt2	YLRA ⁵ Ckt1/Ckt2	MCA ⁶ Ckt1/Ckt2	MOP ⁷ Ckt1/Ckt2
300	200/60/3	1							n/a				
	200/60/3	2	3	14/6	1.5	6.5	7.3	1.2	386-386/386	2525-2525/2525	821-821/821	965/526	1200/800
	230/60/3	1							n/a				
	230/60/3	2	3	14/6	1.5	6.5	7.3	1.2	336-336/336	2126-2126/2126	691-691/691	852/463	1000/700
	380/60/3	1							n/a				
	380/60/3	2	3	14/6	1.5	3.5	3.7	1.2	203-203/203	1306-1306/1306	424-424/424	508/277	700/450
	460/60/3	1	3	20	1.5	3	3.7	1.2	168-168/168	1065-1065/1065	346-346/346	612	700
	460/60/3	2	3	14/6	1.5	3	3.7	1.2	168-168/168	1065-1065/1065	346-346/346	423/231	500/350
	575/60/3	1	3	20	1.5	2.5	3.7	1.2	134-134/134	853-853/853	277-277/277	492	600
	575/60/3	2	3	14/6	1.5	2.5	3.7	1.2	134-134/134	853-853/853	277-277/277	340/185	450/300
350	200/60/3	1							n/a				
	200/60/3	2	4	12/12	1.5	6.5	7.3	1.2	320-320/ 320-320	2156-2156/ 2156-2156	701-701/ 701-701	804/804	1000/1000
	230/60/3	1							n/a				
	230/60/3	2	4	12/12	1.5	6.5	7.3	1.2	278-278/ 278-278	1756-1756/ 1756-1756	571-571/ 571-571	709/709	800/800
	380/60/3	1							n/a				
	380/60/3	2	4	12/12	1.5	3.5	3.7	1.2	168-168/ 168-168	1060-1060/ 1060-1060	345-345/ 345-345	423/423	500/500
	460/60/3	1	4	24	1.5	3	3.7	1.2	139-139/ 139-139	878-878/ 878-878	285-285/ 285-285	669	800
	460/60/3	2	4	12/12	1.5	3	3.7	1.2	139-139/ 139-139	878-878/ 878-878	285-285/ 285-285	352/352	450/450
	575/60/3	1	4	24	1.5	2.5	3.7	1.2	111-111/ 111-111	705-705/ 705-705	229-229/ 229-229	539	600
	575/60/3	2	4	12/12	1.5	2.5	3.7	1.2	111-111/ 111-111	705-705/ 705-705	229-229/ 229-229	284/284	350/350
400	200/60/3	1							n/a				
	200/60/3	2	4	14/14	1.5	6.5	7.3	1.59	386-386/ 386-386	2525-2525/ 2525-2525	821-821/ 821-821	965/965	1200/1200
	230/60/3	1							n/a				
	230/60/3	2	4	14/14	1.5	6.5	7.3	1.59	336-336/ 336-336	2126-2126/ 2126-2126	691-691/ 691-691	852/852	1000/1000
	200/60/3	1							n/a				
	380/60/3	2	4	14/14	1.5	3.5	3.7	1.59	203-203/ 203-203	1306-1306/ 1306-1306	424-424/ 424-424	508/508	700/700
	460/60/3	1	4	28	1.5	3	3.7	1.59	168-168/ 168-168	1065-1065/ 1065-1065	346-346/ 346-346	804	900
	460/60/3	2	4	14/14	1.5	3	3.7	1.59	168-168/ 168-168	1065-1065/ 1065-1065	346-346/ 346-346	423/423	500/500
	575/60/3	1	4	28	1.5	2.5	3.7	1.59	134-134/ 134-134	853-853/853-853	277-277/277- 277	647	700
	575/60/3	2	4	14/14	1.5	2.5	3.7	1.59	134-134/ 134-134	853-853/853-853	277-277/ 277-277	340/340	450/450

Notes:

1. Voltage Utilization Range: +/- 10% of rated voltage. Rated voltage (use range): 200/60/3 (180-220), 230/60/3 (208-254), 380/60/3 (342-418), 460/60/3 (414-506), 575/60/3 (516-633)
2. As standard, 140-250 ton units have a single point power connection. Optional dual point power connections are available. As standard, 275-500 ton units have dual point power connections. Optional single point power connections are available on 460V and 575V/60 Hz units.
3. Control VA includes operational controls only. It does not include evaporator heaters. A separate 115/60/1, 20 amp customer provided power connection is required to power the evaporator heaters (1640 watts).
4. RLA - Rated Load Amps
5. XLRA - Locked Rotor Amps - based on full winding (x-line) start units). YLRA for wye-delta starters is ~1/3 of LRA of x-line units.
6. MCA - Minimum Circuit Ampacity - 125 percent of largest compressor RLA plus 100 percent of all other loads.
7. Max fuse or MOPD = 225 percent of the largest compressor RLA plus 100 percent of the second compressor RLA, plus the sum of the condenser fan FLA. (Use FLA per circuit, NOT FLA for the entire unit).
8. Local codes may take precedence.
9. All ambient means standard, low, high and wide ambient options.



Electrical Data

Table 4. Extra efficiency – high and wide ambient options

Unit Size	Rated Voltage ¹	# Power Conn ²	# Comp	# Fan Ckt1/Ckt2	Fan kW	Fan FLA	VFD Input	Cntrl kVA ³	RLA ⁴ Ckt1/Ckt2	XLRA ⁵ Ckt1/Ckt2	YLRA ⁵ Ckt1/Ckt2	MCA ⁶ Ckt1/Ckt2	MOP ⁷ Ckt1/Ckt2
140 XE	200/60/3	1	2	12	1.5	6.5	7.3	0.83	270/270	1845/1845	600/600	691	800
	200/60/3	2	2	6/6	1.5	6.5	7.3	0.83	270/270	1845/1845	600/600	381/381	600/600
	230/60/3	1	2	12	1.5	6.5	7.3	0.83	235/235	1556/1556	506/506	612	800
	230/60/3	2	2	6/6	1.5	6.5	7.3	0.83	235/235	1556/1556	506/506	337/337	500/500
	380/60/3	1	2	12	1.5	3.5	3.7	0.83	142/142	973/973	316/316	364	500
	380/60/3	2	2	6/6	1.5	3.5	3.7	0.83	142/142	973/973	316/316	201/201	300/300
	460/60/3	1	2	12	1.5	3	3.7	0.83	118/118	774/774	252/252	305	400
	460/60/3	2	2	6/6	1.5	3	3.7	0.83	118/118	774/774	252/252	168/168	250/250
	575/60/3	1	2	12	1.5	2.5	3.7	0.83	94/94	631/631	205/205	245	300
	575/60/3	2	2	6/6	1.5	2.5	3.7	0.83	94/94	631/631	205/205	135/135	225/225
155 XE	200/60/3	1	2	13	1.5	6.5	7.3	0.83	320/270	2156/1845	701/600	760	1000
	200/60/3	2	2	7/6	1.5	6.5	7.3	0.83	320/270	2156/1845	701/600	450/381	700/600
	230/60/3	1	2	13	1.5	6.5	7.3	0.83	278/235	1756/1556	571/506	672	800
	230/60/3	2	2	7/6	1.5	6.5	7.3	0.83	278/235	1756/1556	571/506	397/337	600/500
	380/60/3	1	2	13	1.5	3.5	3.7	0.83	168/142	1060/973	345/316	400	500
	380/60/3	2	2	7/6	1.5	3.5	3.7	0.83	168/142	1060/973	345/316	237/201	400/300
	460/60/3	1	2	13	1.5	3	3.7	0.83	139/118	878/774	285/252	334	450
	460/60/3	2	2	7/6	1.5	3	3.7	0.83	139/118	878/774	285/252	197/168	300/250
	575/60/3	1	2	13	1.5	2.5	3.7	0.83	111/94	705/631	229/205	269	350
	575/60/3	2	2	7/6	1.5	2.5	3.7	0.83	111/94	705/631	229/205	159/135	250/225
170 XE	200/60/3	1	2	14	1.5	6.5	7.3	0.83	320/320	2156/2156	701/701	817	1000
	200/60/3	2	2	7/7	1.5	6.5	7.3	0.83	320/320	2156/2156	701/701	450/450	700/700
	230/60/3	1	2	14	1.5	6.5	7.3	0.83	278/278	1756/1756	571/571	722	800
	230/60/3	2	2	7/7	1.5	6.5	7.3	0.83	278/278	1756/1756	571/571	397/397	600/600
	380/60/3	1	2	14	1.5	3.5	3.7	0.83	168/168	1060/1060	345/345	430	500
	380/60/3	2	2	7/7	1.5	3.5	3.7	0.83	168/168	1060/1060	345/345	237/237	400/400
	460/60/3	1	2	14	1.5	3	3.7	0.83	139/139	878/878	285/285	358	450
	460/60/3	2	2	7/7	1.5	3	3.7	0.83	139/139	878/878	285/285	197/197	300/300
	575/60/3	1	2	14	1.5	2.5	3.7	0.83	111/111	705/705	229/229	289	350
	575/60/3	2	2	7/7	1.5	2.5	3.7	0.83	111/111	705/705	229/229	159/159	250/250
185 XE	200/60/3	1	2	14	1.5	6.5	7.3	0.83	386/320	2525/2156	821/701	899	1200
	200/60/3	2	2	8/6	1.5	6.5	7.3	0.83	386/320	2525/2156	821/701	539/444	800/700
	230/60/3	1	2	14	1.5	6.5	7.3	0.83	336/278	2126/1756	691-571	794	1000
	230/60/3	2	2	8/6	1.5	6.5	7.3	0.83	336/278	2126/1756	691/571	476/391	800/600
	380/60/3	1	2	14	1.5	3.5	3.7	0.83	203/168	1306/1060	424/345	473	600
	380/60/3	2	2	8/6	1.5	3.5	3.7	0.83	203/168	1306/1060	424/345	284/233	450/400
	460/60/3	1	2	14	1.5	3	3.7	0.83	168/139	1065/878	346/285	394	500
	460/60/3	2	2	8/6	1.5	3	3.7	0.83	168/139	1065/878	346/285	237/194	400/300
	575/60/3	1	2	14	1.5	2.5	3.7	0.83	134/111	853/705	277/229	317	450
	575/60/3	2	2	8/6	1.5	2.5	3.7	0.83	134/111	853/705	277/229	190/156	300/250

Table 4. Extra efficiency – high and wide ambient options

Unit Size	Rated Voltage ¹	# Power Conn ²	# Comp	# Fan Ckt1/Ckt2	Fan kW	Fan FLA	VFD Input	Cntrl kVA ³	RLA ⁴ Ckt1/Ckt2	XLRA ⁵ Ckt1/Ckt2	YLRA ⁵ Ckt1/Ckt2	MCA ⁶ Ckt1/Ckt2	MOP ⁷ Ckt1/Ckt2
200 XE	200/60/3	1	2	16	1.5	6.5	7.3	0.83	386/386	2525/2525	821/821	978	1200
	200/60/3	2	2	8/8	1.5	6.5	7.3	0.83	386/386	2525/2525	821/821	539/539	800/800
	230/60/3	1	2	16	1.5	6.5	7.3	0.83	336/336	2126/2126	691/691	865	1200
	230/60/3	2	2	8/8	1.5	6.5	7.3	0.83	336/336	2126/2126	691/691	476/476	800/800
	380/60/3	1	2	16	1.5	3.5	3.7	0.83	203/203	1306/1306	424/424	515	700
	380/60/3	2	2	8/8	1.5	3.5	3.7	0.83	203/203	1306/1306	424/424	284/284	450/450
	460/60/3	1	2	16	1.5	3	3.7	0.83	168/168	1065/1065	346/346	429	500
	460/60/3	2	2	8/8	1.5	3	3.7	0.83	168/168	1065/1065	346/346	237/237	400/400
	575/60/3	1	2	16	1.5	2.5	3.7	0.83	134/134	853/853	277/277	345	450
	575/60/3	2	2	8/8	1.5	2.5	3.7	0.83	134/134	853/853	277/277	190/190	300/300
250 XE	200/60/3	1										NA	
	200/60/3	2	3	12/6	1.5	6.5	7.3	1.2	270-270/320	1845-1845/2156	600-600/701	693/446	800/700
	230/60/3	1										NA	
	230/60/3	2	3	12/6	1.5	6.5	7.3	1.2	235-235/278	1556-1556/1756	506-506/571	614/393	800/600
	380/60/3	1										NA	
	380/60/3	2	3	12/6	1.5	3.5	3.7	1.2	142-142/168	973-973/1060	316-316/345	365/234	500/400
	460/60/3	1	3	18	1.5	3	3.7	1.2	118-118/139	774-774/878	252-252/285	468	600
	460/60/3	2	3	12/6	1.5	3	3.7	1.2	118-118/139	774-774/878	252-252/285	306/195	400/300
	575/60/3	1	3	18	1.5	2.5	3.7	1.2	94-94/111	631-631/705	205-205/229	377	450
	575/60/3	2	3	12/6	1.5	2.5	3.7	1.2	94-94/111	631-631/705	205-205/229	246/157	300/250
275 XE	200/60/3	1										NA	
	200/60/3	2	3	14/6	1.5	6.5	7.3	1.2	320-320/320	2156-2156/2156	701-701/701	819/446	1000/700
	230/60/3	1										NA	
	230/60/3	2	3	14/6	1.5	6.5	7.3	1.2	278-278/278	1756-1756/1756	571-571/571	723/393	1000/600
	380/60/3	1										NA	
	380/60/3	2	3	14/6	1.5	3.5	3.7	1.2	168-168/168	1060-1060/1060	345-345/345	431/234	500/400
	460/60/3	1	3	20	1.5	3	3.7	1.2	139-139/139	878-878/878	285-285/285	516	600
	460/60/3	2	3	14/6	1.5	3	3.7	1.2	139-139/139	878-878/878	285-285/285	359/195	450/300
	575/60/3	1	3	20	1.5	2.5	3.7	1.2	111-111/111	705-705/705	229-229/229	416	500
	575/60/3	2	3	14/6	1.5	2.5	3.7	1.2	111-111/111	705-705/705	229-229/229	289/157	400/250
300 XE	200/60/3	1										NA	
	200/60/3	2	4	12/12	1.5	6.5	7.3	1.2	270-270/270-270	1845-1845/1845-1845	600-600/600-600	693/693	800/800
	230/60/3	1										NA	
	230/60/3	2	4	12/12	1.5	6.5	7.3	1.2	235-235/235-235	1556-1556/1556-1556	506-506/506-506	614/614	800/800
	380/60/3	1										NA	
	380/60/3	2	4	12/12	1.5	3.5	3.7	1.2	142-142/142-142	973-973/973-973	316-316/316-316	365/365	500/500
	460/60/3	1	4	24	1.5	3	3.7	1.2	118-118/118-118	774-774/774-774	252-252/252-252	579	600
	460/60/3	2	4	12/12	1.5	3	3.7	1.2	118-118/118-118	774-774/774-774	252-252/252-252	306/306	400/400
	575/60/3	1	4	24	1.5	2.5	3.7	1.2	94-94/94-94	631-631/631-631	205-205/205-205	466	500
	575/60/3	2	4	12/12	1.5	2.5	3.7	1.2	94-94/94-94	631-631/631-631	205-205/205-205	246/246	300/300



Electrical Data

Table 4. Extra efficiency – high and wide ambient options

Unit Size	Rated Voltage ¹	# Power Conn ²	# Comp	# Fan Ckt1/Ckt2	Fan kW	Fan FLA	VFD Input	Cntrl kVA ³	RLA ⁴ Ckt1/Ckt2	XLRA ⁵ Ckt1/Ckt2	YLRA ⁵ Ckt1/Ckt2	MCA ⁶ Ckt1/Ckt2	MOP ⁷ Ckt1/Ckt2
	200/60/3	1										NA	
	200/60/3	2	4	14/14	1.5	6.5	7.3	1.59	320-320/ 320-320	2156-2156/2156- 2156	701-701/ 701-701	821/821	1000/1000
	230/60/3	1										NA	
	230/60/3	2	4	14/14	1.5	6.5	7.3	1.59	278-278/ 278-278	1756-1756/1756- 1756	571-571/ 571-571	725/725	1000/1000
	380/60/3	1										NA	
350 XE	380/60/3	2	4	14/14	1.5	3.5	3.7	1.59	168-168/ 168-168	1060-1060/1060- 1060	345-345/ 345-345	432/432	500/500
	460/60/3	1	4	28	1.5	3	3.7	1.59	139-139/ 139-139	878-878/ 878-878	285-285/ 285-285	681	800
	460/60/3	2	4	14/14	1.5	3	3.7	1.59	139-139/ 139-139	878-878/ 878-878	285-285/ 285-285	360/360	450/450
	575/60/3	1	4	28	1.5	2.5	3.7	1.59	111-111/ 111-111	705-705/ 705-705	229-229/ 229-229	549	600
	575/60/3	2	4	14/14	1.5	2.5	3.7	1.59	111-111/ 111-111	705-705/ 705-705	229-229/ 229-229	290/290	400/400

Notes:

1. Voltage Utilization Range: +/- 10% of rated voltage. Rated voltage (use range): 200/60/3 (180-220), 230/60/3 (208-254), 380/60/3 (342-418), 460/60/3 (414-506), 575/60/3 (516-633)
2. As standard, 140-250 ton units have a single point power connection. Optional dual point power connections are available. As standard, 275-500 ton units have dual point power connections. Optional single point power connections are available on 460V and 575V/60 Hz units.
3. Control VA includes operational controls only. It does not include evaporator heaters. A separate 115/60/1, 20 amp customer provided power connection is required to power the evaporator heaters (1640 watts).
4. RLA - Rated Load Amps
5. XLRA - Locked Rotor Amps - based on full winding (x-line) start units). YLRA for wye-delta starters is ~1/3 of LRA of x-line units.
6. MCA - Minimum Circuit Ampacity - 125 percent of largest compressor RLA plus 100 percent of all other loads.
7. Max fuse or MOPD = 225 percent of the largest compressor RLA plus 100 percent of the second compressor RLA, plus the sum of the condenser fan FLA. (Use FLA per circuit, NOT FLA for the entire unit).
8. Local codes may take precedence.
9. All ambient means standard, low, high and wide ambient options.

Table 5. Customer wire selection — standard and high efficiency

Unit Size	Single point power			Dual point power - Ckt 1			Dual point power - Ckt 2			
	Volt	Term	Disc	Circuit Breaker	Term	Disc	Circuit Breaker	Term	Disc	Circuit Breaker
350 HIGH	200A		n/a		(4) 2 AWG - 600 MCM	(4) 250 MCM - 500 MCM	(4) 250 MCM - 500 MCM	(4) 2 AWG - 600 MCM	(4) 250 MCM - 500 MCM	(4) 250 MCM - 500 MCM
	230A		n/a		(4) 2 AWG - 600 MCM	(3) 1/0 AWG - 500 MCM	(4) 250 MCM - 500 MCM	(4) 2 AWG - 600 MCM	(3) 1/0 AWG - 500 MCM	(4) 250 MCM - 500 MCM
	380A		n/a		(2) 2 AWG - 600 MCM	(2) 3/0 AWG - 500 MCM	(2) 3/0 AWG - 500 MCM	(2) 2 AWG - 600 MCM	(2) 3/0 AWG - 500 MCM	(2) 3/0 AWG - 500 MCM
	460A		n/a	(4) 2 AWG - 600 MCM	(2) 2 AWG - 600 MCM	(2) 3/0 AWG - 500 MCM	(2) 3/0 AWG - 500 MCM	(2) 2 AWG - 600 MCM	(2) 3/0 AWG - 500 MCM	(2) 3/0 AWG - 500 MCM
	575A		n/a	(4) 2 AWG - 600 MCM	(2) 2 AWG - 600 MCM	(2) 3/0 AWG - 500 MCM	(2) 3/0 AWG - 500 MCM	(2) 2 AWG - 600 MCM	(2) 3/0 AWG - 500 MCM	(2) 3/0 AWG - 500 MCM
400	200A		n/a		(4) 2 AWG - 600 MCM	(4) 250 MCM - 500 MCM	(4) 250 MCM - 500 MCM	(4) 2 AWG - 600 MCM	(4) 250 MCM - 500 MCM	(4) 250 MCM - 500 MCM
	230A		n/a		(4) 2 AWG - 600 MCM	(4) 250 MCM - 500 MCM	(4) 250 MCM - 500 MCM	(4) 2 AWG - 600 MCM	(4) 250 MCM - 500 MCM	(4) 250 MCM - 500 MCM
	380A		n/a		(3) 2 AWG - 600 MCM	(3) 1/0 AWG - 500 MCM	(3) 1/0 AWG - 500 MCM	(3) 2 AWG - 600 MCM	(3) 1/0 AWG - 500 MCM	(3) 1/0 AWG - 500 MCM
	460A		n/a	(4) 2 AWG - 600 MCM	(2) 2 AWG - 600 MCM	(2) 3/0 AWG - 500 MCM	(2) 3/0 AWG - 500 MCM	(2) 2 AWG - 600 MCM	(2) 3/0 AWG - 500 MCM	(2) 3/0 AWG - 500 MCM
	575A		n/a	(4) 2 AWG - 600 MCM	(2) 2 AWG - 600 MCM	(2) 3/0 AWG - 500 MCM	(2) 3/0 AWG - 500 MCM	(2) 2 AWG - 600 MCM	(2) 3/0 AWG - 500 MCM	(2) 3/0 AWG - 500 MCM
450	200A		n/a		(4) 2 AWG - 600 MCM	(4) 250 MCM - 500 MCM	(4) 250 MCM - 500 MCM	(4) 2 AWG - 600 MCM	(4) 250 MCM - 500 MCM	(4) 250 MCM - 500 MCM
	230A		n/a		(4) 2 AWG - 600 MCM	(4) 250 MCM - 500 MCM	(4) 250 MCM - 500 MCM	(4) 2 AWG - 600 MCM	(4) 250 MCM - 500 MCM	(4) 250 MCM - 500 MCM
	380A		n/a		(3) 2 AWG - 600 MCM	(3) 1/0 AWG - 500 MCM	(3) 1/0 AWG - 500 MCM	(3) 2 AWG - 600 MCM	(3) 1/0 AWG - 500 MCM	(3) 1/0 AWG - 500 MCM
	460A		n/a	(4) 2 AWG - 600 MCM	(2) 2 AWG - 600 MCM	(2) 3/0 AWG - 500 MCM	(2) 3/0 AWG - 500 MCM	(2) 2 AWG - 600 MCM	(2) 3/0 AWG - 500 MCM	(2) 3/0 AWG - 500 MCM
	575A		n/a	(4) 2 AWG - 600 MCM	(2) 2 AWG - 600 MCM	(2) 3/0 AWG - 500 MCM	(2) 3/0 AWG - 500 MCM	(2) 2 AWG - 600 MCM	(2) 3/0 AWG - 500 MCM	(2) 3/0 AWG - 500 MCM
500	200A		n/a		(4) 2 AWG - 600 MCM	(4) 250 MCM - 500 MCM	(4) 250 MCM - 500 MCM	(4) 2 AWG - 600 MCM	(4) 250 MCM - 500 MCM	(4) 250 MCM - 500 MCM
	230A		n/a		(4) 2 AWG - 600 MCM	(4) 250 MCM - 500 MCM	(4) 250 MCM - 500 MCM	(4) 2 AWG - 600 MCM	(4) 250 MCM - 500 MCM	(4) 250 MCM - 500 MCM
	380A		n/a		(3) 2 AWG - 600 MCM	(3) 1/0 AWG - 500 MCM	(3) 1/0 AWG - 500 MCM	(3) 2 AWG - 600 MCM	(3) 1/0 AWG - 500 MCM	(3) 1/0 AWG - 500 MCM
	460A		n/a	(4) 2 AWG - 600 MCM	(2) 2 AWG - 600 MCM	(2) 3/0 AWG - 500 MCM	(2) 3/0 AWG - 500 MCM	(2) 2 AWG - 600 MCM	(2) 3/0 AWG - 500 MCM	(2) 3/0 AWG - 500 MCM
	575A		n/a	(4) 2 AWG - 600 MCM	(2) 2 AWG - 600 MCM	(2) 3/0 AWG - 500 MCM	(2) 3/0 AWG - 500 MCM	(2) 2 AWG - 600 MCM	(2) 3/0 AWG - 500 MCM	(2) 3/0 AWG - 500 MCM

1. Non-fused unit disconnect and circuit breaker are optional.
2. Copper wire only, based on nameplate minimum circuit ampacity (MCA).
3. Circuit breaker sizes are for factory mounted only.
4. n/a - not available

Table 6. Customer wire selection – extra efficiency (continued)

Unit Size	Volt	Term	Disc	Single point power			Dual point power - Ckt 1			Dual point power - Ckt 2		
				Circuit Breaker	Term	Disc	Circuit Breaker	Term	Disc	Circuit Breaker	Term	Disc
250	200A	n/a	n/a	n/a	(4) 2 AWG - 600 MCM	(3) 1/0 AWG - 500 MCM	(3) 1/0 AWG - 500 MCM	(3) 2 AWG - 600 MCM	(3) 1/0 AWG - 500 MCM	(3) 1/0 AWG - 500 MCM		
	230A	n/a	n/a	n/a	(4) 2 AWG - 600 MCM	(3) 1/0 AWG - 500 MCM	(3) 1/0 AWG - 500 MCM	(3) 2 AWG - 600 MCM	(2) 3/0 AWG - 500 MCM	(2) 3/0 AWG - 500 MCM		
	380A	n/a	n/a	n/a	(2) 2 AWG - 600 MCM	(2) 3/0 AWG - 500 MCM	(2) 3/0 AWG - 500 MCM	(2) 2 AWG - 600 MCM	(2) 3/0 AWG - 500 MCM	(2) 3/0 AWG - 500 MCM		
	460A	n/a	n/a	(4) 250 MCM - 500 MCM	(2) 2 AWG - 600 MCM	(2) 3/0 AWG - 500 MCM	(2) 3/0 AWG - 500 MCM	(2) 2 AWG - 600 MCM	(2) 3/0 AWG - 500 MCM	(2) 3/0 AWG - 500 MCM		
	575A	n/a	n/a	(4) 250 MCM - 500 MCM	(2) 2 AWG - 600 MCM	(2) 3/0 AWG - 500 MCM	(2) 3/0 AWG - 500 MCM	(2) 2 AWG - 600 MCM	(2) 3/0 AWG - 500 MCM	(2) 3/0 AWG - 500 MCM		
275	200A	n/a	n/a	n/a	(4) 2 AWG - 600 MCM	(4) 250 MCM - 500 MCM	(4) 250 MCM - 500 MCM	(3) 2 AWG - 600 MCM	(3) 1/0 AWG - 500 MCM	(3) 1/0 AWG - 500 MCM		
	230A	n/a	n/a	n/a	(4) 2 AWG - 600 MCM	(4) 250 MCM - 500 MCM	(4) 250 MCM - 500 MCM	(3) 2 AWG - 600 MCM	(2) 3/0 AWG - 500 MCM	(2) 3/0 AWG - 500 MCM		
	380A	n/a	n/a	n/a	(2) 2 AWG - 600 MCM	(2) 3/0 AWG - 500 MCM	(2) 3/0 AWG - 500 MCM	(2) 2 AWG - 600 MCM	(2) 3/0 AWG - 500 MCM	(2) 3/0 AWG - 500 MCM		
	460A	n/a	n/a	(4) 250 MCM - 500 MCM	(2) 2 AWG - 600 MCM	(2) 3/0 AWG - 500 MCM	(2) 3/0 AWG - 500 MCM	(2) 2 AWG - 600 MCM	(2) 3/0 AWG - 500 MCM	(2) 3/0 AWG - 500 MCM		
	575A	n/a	n/a	(4) 250 MCM - 500 MCM	(2) 2 AWG - 600 MCM	(2) 3/0 AWG - 500 MCM	(2) 3/0 AWG - 500 MCM	(2) 2 AWG - 600 MCM	(2) 3/0 AWG - 500 MCM	(2) 3/0 AWG - 500 MCM		
300	200A	n/a	n/a	n/a	(4) 2 AWG - 600 MCM	(3) 1/0 AWG - 500 MCM	(3) 1/0 AWG - 500 MCM	(4) 2 AWG - 600 MCM	(3) 1/0 AWG - 500 MCM	(3) 1/0 AWG - 500 MCM		
	230A	n/a	n/a	n/a	(4) 2 AWG - 600 MCM	(3) 1/0 AWG - 500 MCM	(3) 1/0 AWG - 500 MCM	(4) 2 AWG - 600 MCM	(3) 1/0 AWG - 500 MCM	(3) 1/0 AWG - 500 MCM		
	380A	n/a	n/a	n/a	(2) 2 AWG - 600 MCM	(2) 3/0 AWG - 500 MCM	(2) 3/0 AWG - 500 MCM	(2) 2 AWG - 600 MCM	(2) 3/0 AWG - 500 MCM	(2) 3/0 AWG - 500 MCM		
	460A	n/a	n/a	(4) 250 MCM - 500 MCM	(2) 2 AWG - 600 MCM	(2) 3/0 AWG - 500 MCM	(2) 3/0 AWG - 500 MCM	(2) 2 AWG - 600 MCM	(2) 3/0 AWG - 500 MCM	(2) 3/0 AWG - 500 MCM		
	575A	n/a	n/a	(4) 250 MCM - 500 MCM	(2) 2 AWG - 600 MCM	(2) 3/0 AWG - 500 MCM	(2) 3/0 AWG - 500 MCM	(2) 2 AWG - 600 MCM	(2) 3/0 AWG - 500 MCM	(2) 3/0 AWG - 500 MCM		
350	200A	n/a	n/a	n/a	(4) 2 AWG - 600 MCM	(4) 250 MCM - 500 MCM	(4) 250 MCM - 500 MCM	(4) 2 AWG - 600 MCM	(4) 250 MCM - 500 MCM	(4) 250 MCM - 500 MCM		
	230A	n/a	n/a	n/a	(4) 2 AWG - 600 MCM	(4) 250 MCM - 500 MCM	(4) 250 MCM - 500 MCM	(4) 2 AWG - 600 MCM	(4) 250 MCM - 500 MCM	(4) 250 MCM - 500 MCM		
	380A	n/a	n/a	n/a	(2) 2 AWG - 600 MCM	(2) 3/0 AWG - 500 MCM	(2) 3/0 AWG - 500 MCM	(2) 2 AWG - 600 MCM	(2) 3/0 AWG - 500 MCM	(2) 3/0 AWG - 500 MCM		
	460A	n/a	n/a	(4) 250 MCM - 500 MCM	(2) 2 AWG - 600 MCM	(2) 3/0 AWG - 500 MCM	(2) 3/0 AWG - 500 MCM	(2) 2 AWG - 600 MCM	(2) 3/0 AWG - 500 MCM	(2) 3/0 AWG - 500 MCM		
	575A	n/a	n/a	(4) 250 MCM - 500 MCM	(2) 2 AWG - 600 MCM	(2) 3/0 AWG - 500 MCM	(2) 3/0 AWG - 500 MCM	(2) 2 AWG - 600 MCM	(2) 3/0 AWG - 500 MCM	(2) 3/0 AWG - 500 MCM		

1. Non-fused unit disconnect and circuit breaker are optional.
2. Copper wire only, based on nameplate minimum circuit ampacity (MCA).
3. Circuit breaker sizes are for factory mounted only.
4. n/a - not available

Electrical Connection

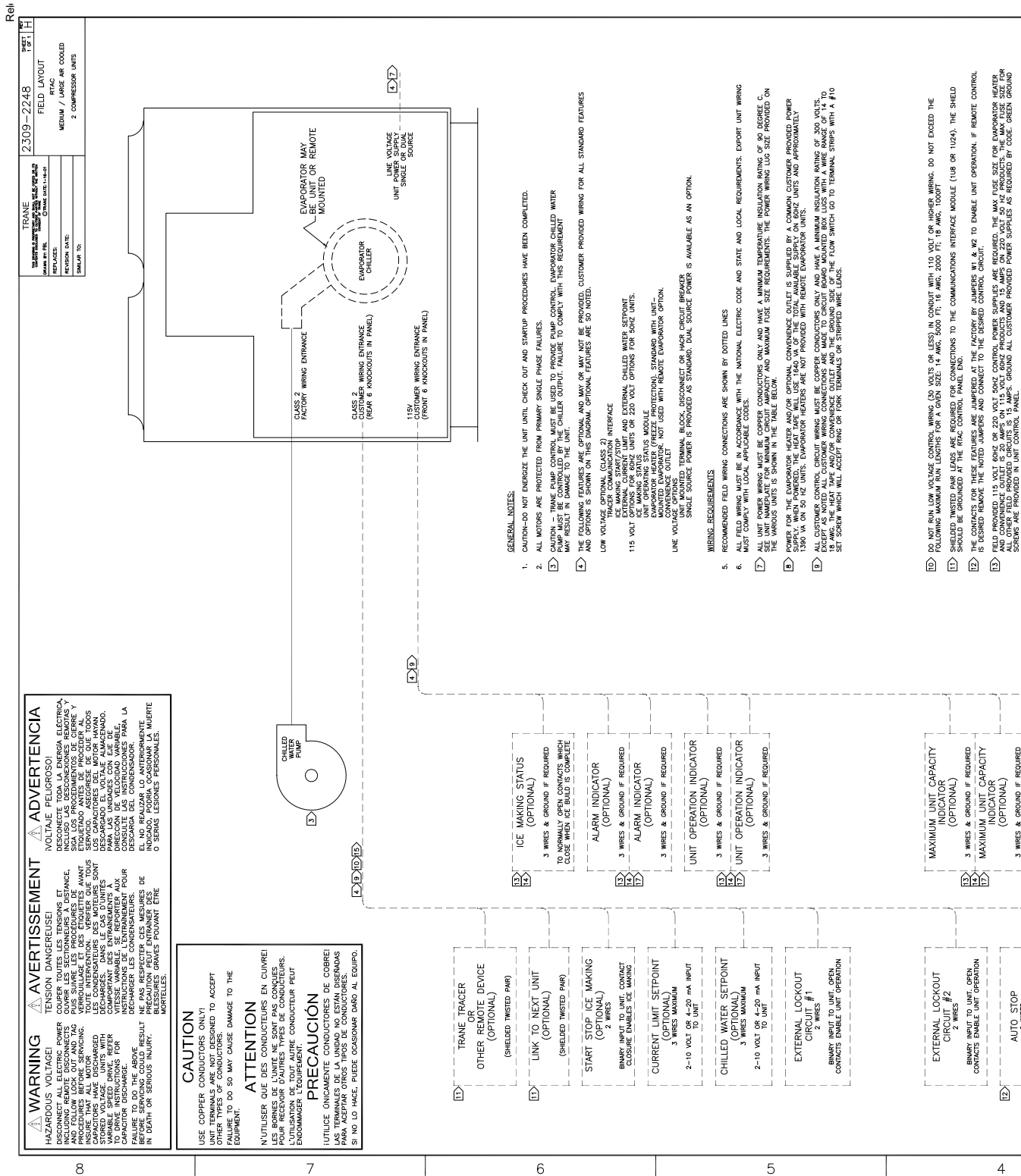

- 7 MUST COMPLY WITH LOCAL APPLICABLE CODES.
- 8 ALL UNIT POWER WIRING MUST BE COPPER CONDUCTORS ONLY AND HAVE A MINIMUM TEMPERATURE INSULATION RATING OF 20 DEGREE C. AND MINIMUM FUSE SIZE REQUIREMENTS. THE POWER WIRING LUG SIZE PROVIDED ON THE VARIOUS UNITS IS SHOWN IN THE TABLE BELOW.
- 9 POWER FOR THE EXHAUSTOR HEATER AND/OR OPTIONAL CONVENIENCE OUTLET IS SUPPLIED BY A COMMON CUSTOMER PROVIDED POWER SUPPLY. WHEN POWERED, THE HEAT TAPE WILL USE 1640 VA OF THE TOTAL AVAILABLE SUPPLY ON 60HZ UNITS AND APPROXIMATELY 1000 VA ON 50 HZ UNITS. THE EXHAUSTOR HEATER AND/OR CONVENIENCE OUTLET MUST BE INSTALLED WITH A MINIMUM INSULATION RATING OF 300 VOLTS. EXCEPT AS NOTED, ALL CUSTOMER WIRING CONNECTIONS ARE MADE TO CIRCUIT BOARD MOUNTED BOX ALONG WITH A WIRE RANGE OF 14 TO 18 AWG. THE HEAT TAPE AND/OR CONVENIENCE OUTLET AND THE GROUND SIDE OF THE FLOW SWITCH GO TO TERMINAL STRIPS WITH A #10 SET SCREW WHICH WILL ACCEPT WIRE OR BORN TERMINALS OR STRIPPED WIRE LUGS.

- 10 DO NOT RUN LOW VOLTAGE CONTROL WIRING (30 VOLTS OR LESS) IN CONDUIT WITH 110 VOLT OR HIGHER WIRING. DO NOT EXCEED THE FOLLOWING MAXIMUM RUN LENGTHS FOR A GIVEN SIZE: 14 AWG, 5000 FT; 16 AWG, 2000 FT; 18 AWG, 1000FT
- 11 SHIELD ALL WIRING LEADS ARE REQUIRED FOR CONNECTIONS TO THE COMMUNICATIONS INTERFACE MODULE (L18 OR L1024). THE SHIELD SHOULD BE CONNECTED TO THE COMMUNICATIONS INTERFACE MODULE (L18 OR L1024).
- 12 THE CONTACTS FOR THESE FEATURES ARE JUMPED AT THE FACTORY BY JUMPERS W1 & W2 TO EMERGE UNIT OPERATION. IF REMOTE CONTROL IS DESIRED REMOVE THE NOTED JUMPERS AND CONNECT TO THE DESIRED CONTROL CIRCUIT.
- 13 FIELD PROVIDED 115 VOLT 60HZ OR 220 VOLT 50HZ CONTROL POWER SUPPLIES ARE REQUIRED. THE MAX FUSE SIZE FOR EXHAUSTOR HEATER AND CONVENIENCE OUTLET IS 20 AMPS ON 115 VOLT 60HZ PRODUCTS AND 15 AMPS ON 220 VOLT 50 HZ PRODUCTS. THE MAX FUSE SIZE FOR THE EXHAUSTOR HEATER AND/OR CONVENIENCE OUTLET IS 20 AMPS ON 115 VOLT 60HZ PRODUCTS AND 15 AMPS ON 220 VOLT 50 HZ PRODUCTS. THE MAX FUSE SIZE FOR SCREWS ARE PROVIDED IN UNIT CONTROL PANEL. *GROUND ALL CUSTOMER PROVIDED POWER SUPPLIES AS REQUIRED BY OTHER GREEN BOOK CONTACT RATINGS AND REQUIREMENTS
- 14 UNIT PROVIDED DRY CONTACTS FOR THE EXHAUSTOR PUMP CONTROL, THE UNIT OPERATING STATUS RELAYS AND ICE MAKING STATUS RELAY ARE RATED FOR 7.2 AMPS, RESISTIVE, 2.88 AMPS PILOT DUTY, OR 1/3 HP, 7.2 FLA AT 120 VOLTS 60 HZ. CONTACTS ARE RATED FOR 5 AMPS GENERAL PURPOSE DUTY AT 240 VOLTS.
- 15 ALL UNIT PROVIDED DRY CONTACTS ARE COMPATIBLE WITH DRY CIRCUIT 24 VOLTS DC FOR A 12 MA GENERAL PURPOSE DUTY AT 240 VOLTS.
- 16 FLOW SWITCH & INTERLOCK CONTACTS MUST BE ACCEPTABLE FOR USE IN A 24 VOLT 12 mA CIRCUIT.
- 17 DIFFERENTIAL FUNCTIONS MAY BE CONNECTED TO EITHER OR BOTH OF THE NORMALLY OPEN OR NORMALLY CLOSED RELAY CONTACTS OF EACH OF THE 4 SPDT RELAYS ON THE OPERATING STATUS MODULE.

THE FUNCTIONS OF THE OPERATING STATUS MODULE RELAYS ARE PROGRAMMABLE. SEE IOM FOR DETAILS. DEFAULT FUNCTIONS ARE SHOWN. THE NORMALLY OPEN CONTACTS ON EACH RELAY OPERATE AS FOLLOWS:
 1. THE UNIT OPERATING STATUS RELAY IS USED TO INDICATE THE UNIT IS RUNNING.
 2. THE UNIT OPERATING STATUS RELAY IS USED TO INDICATE THE UNIT IS RUNNING.
 3. THE UNIT OPERATING STATUS RELAY IS USED TO INDICATE THE UNIT IS RUNNING.
 4. THE UNIT OPERATING STATUS RELAY IS USED TO INDICATE THE UNIT IS RUNNING.
 CONTACTS TO THE MAX UNIT CAPACITY INDICATOR CLOSE WHEN ANY COMPRESSOR IS RUNNING.
 CONTACTS TO THE MAX UNIT CAPACITY INDICATOR CLOSE WHEN ANY COMPRESSOR IS RUNNING.
 CONTACTS TO THE MAX UNIT CAPACITY INDICATOR CLOSE WHEN ANY COMPRESSOR IS RUNNING.
 CONTACTS TO THE MAX UNIT CAPACITY INDICATOR CLOSE WHEN ANY COMPRESSOR IS RUNNING.

REPLACEMENT FUSE SIZES		DESIGNATION	VOLTS	CLASS	AMPS
CONDENSER FANS	UNIT SIZE	1F1 THRU 1F12	600	CC	10
	UNIT VOLTAGE/HZ	230/60			8
CONTROL POWER TRANSFORMER PRIMARY	UNIT SIZE	1F13,1F14	600	CC	5
	UNIT VOLTAGE/HZ	380/60			5
	UNIT VOLTAGE/HZ	415/60			4
	UNIT VOLTAGE/HZ	400/50			5
CONTROL POWER TRANSFORMER 2X VOLT SEC.	UNIT SIZE	1F15	600	CC	10
	UNIT VOLTAGE/HZ	1F16 & 1F17	600	CC	5
INVERTER DRIVE AND/OR INVERTER TRANSFORMER PRI.	UNIT SIZE	1F18 THRU 1F23	600	CC	5
	UNIT VOLTAGE/HZ	ALL BUT 575/60			6.25

WIRE SIZE RANGE FOR FACTORY PROVIDED LUGS FOR CUSTOMER POWER WIRING CONNECTIONS

VOLTAGE	SINGLE SOURCE POWER ELECTRICAL CIRCUIT 1 & 2		ELECTRICAL CIRCUIT 1 DUAL SOURCE POWER		ELECTRICAL CIRCUIT 2 DUAL SOURCE POWER	
	UNIT SIZE (TONS)	LUG WIRE SIZE RANGE	UNIT SIZE (TONS)	LUG WIRE SIZE RANGE	UNIT SIZE (TONS)	LUG WIRE SIZE RANGE
200/60/3	140, 155, 170, 185, 200	THREE 1/0 AWG - 500 MCM	140, 155, 170, 185, 200	THREE 3/0 AWG - 500 MCM	140, 155, 170, 185, 200, 225	TWO 3/0 AWG - 500 MCM
230/60/3	170, 185, 200, 225, 250	FOUR 250 MCM - 500 MCM	170, 185, 200	THREE 1/0 AWG - 500 MCM	250	THREE 1/0 AWG - 500 MCM
380/60/3	140, 155, 170, 185	THREE 1/0 AWG - 500 MCM	225, 250	THREE 1/0 AWG - 500 MCM	250	THREE 1/0 AWG - 500 MCM
460/60/3	140, 155, 170, 185	THREE 1/0 AWG - 500 MCM	ALL	TWO 3/0 AWG - 500 MCM	ALL	TWO 3/0 AWG - 500 MCM
575/60/3	200, 225, 250	THREE 1/0 AWG - 500 MCM	ALL	TWO 3/0 AWG - 500 MCM	ALL	TWO 3/0 AWG - 500 MCM
400/50/3	ALL	TWO 3/0 AWG - 500 MCM	ALL	TWO 3/0 AWG - 500 MCM	ALL	TWO 3/0 AWG - 500 MCM

DISCONNECT SWITCH OPTION		ELECTRICAL CIRCUIT 1 DUAL SOURCE POWER		ELECTRICAL CIRCUIT 2 DUAL SOURCE POWER	
VOLTAGE	UNIT SIZE (TONS)	UNIT SIZE (TONS)	LUG WIRE SIZE RANGE	UNIT SIZE (TONS)	LUG WIRE SIZE RANGE
200/60/3	140, 155, 170, 185, 200	140, 155, 170, 185, 200	THREE 1/0 AWG - 500 MCM	140, 155, 170, 185, 200, 225	TWO 3/0 AWG - 500 MCM
230/60/3	170, 185, 200, 225, 250	170, 185, 200	THREE 1/0 AWG - 500 MCM	250	THREE 1/0 AWG - 500 MCM
380/60/3	140, 155, 170, 185	225, 250	THREE 1/0 AWG - 500 MCM	250	THREE 1/0 AWG - 500 MCM
460/60/3	140, 155, 170, 185	ALL	TWO 3/0 AWG - 500 MCM	ALL	TWO 3/0 AWG - 500 MCM
575/60/3	200, 225, 250	ALL	TWO 3/0 AWG - 500 MCM	ALL	TWO 3/0 AWG - 500 MCM

TERMINAL BLOCK OR LUG OPTION		ELECTRICAL CIRCUIT 1 DUAL SOURCE POWER		ELECTRICAL CIRCUIT 2 DUAL SOURCE POWER	
VOLTAGE	UNIT SIZE (TONS)	UNIT SIZE (TONS)	LUG WIRE SIZE RANGE	UNIT SIZE (TONS)	LUG WIRE SIZE RANGE
200/60/3	140, 155, 170, 185, 200	140, 155, 170, 185, 200	THREE 1/0 AWG - 500 MCM	140, 155, 170, 185, 200, 225	TWO 3/0 AWG - 500 MCM
230/60/3	170, 185, 200, 225, 250	170, 185, 200	THREE 1/0 AWG - 500 MCM	250	THREE 1/0 AWG - 500 MCM
380/60/3	140, 155, 170, 185	225, 250	THREE 1/0 AWG - 500 MCM	250	THREE 1/0 AWG - 500 MCM
460/60/3	140, 155, 170, 185	ALL	TWO 3/0 AWG - 500 MCM	ALL	TWO 3/0 AWG - 500 MCM
575/60/3	200, 225, 250	ALL	TWO 3/0 AWG - 500 MCM	ALL	TWO 3/0 AWG - 500 MCM

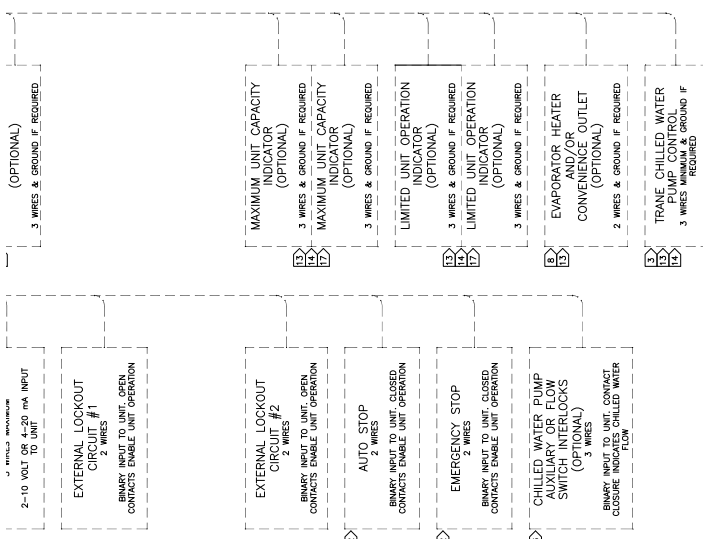

5 4 3 2 1

Electrical Connection

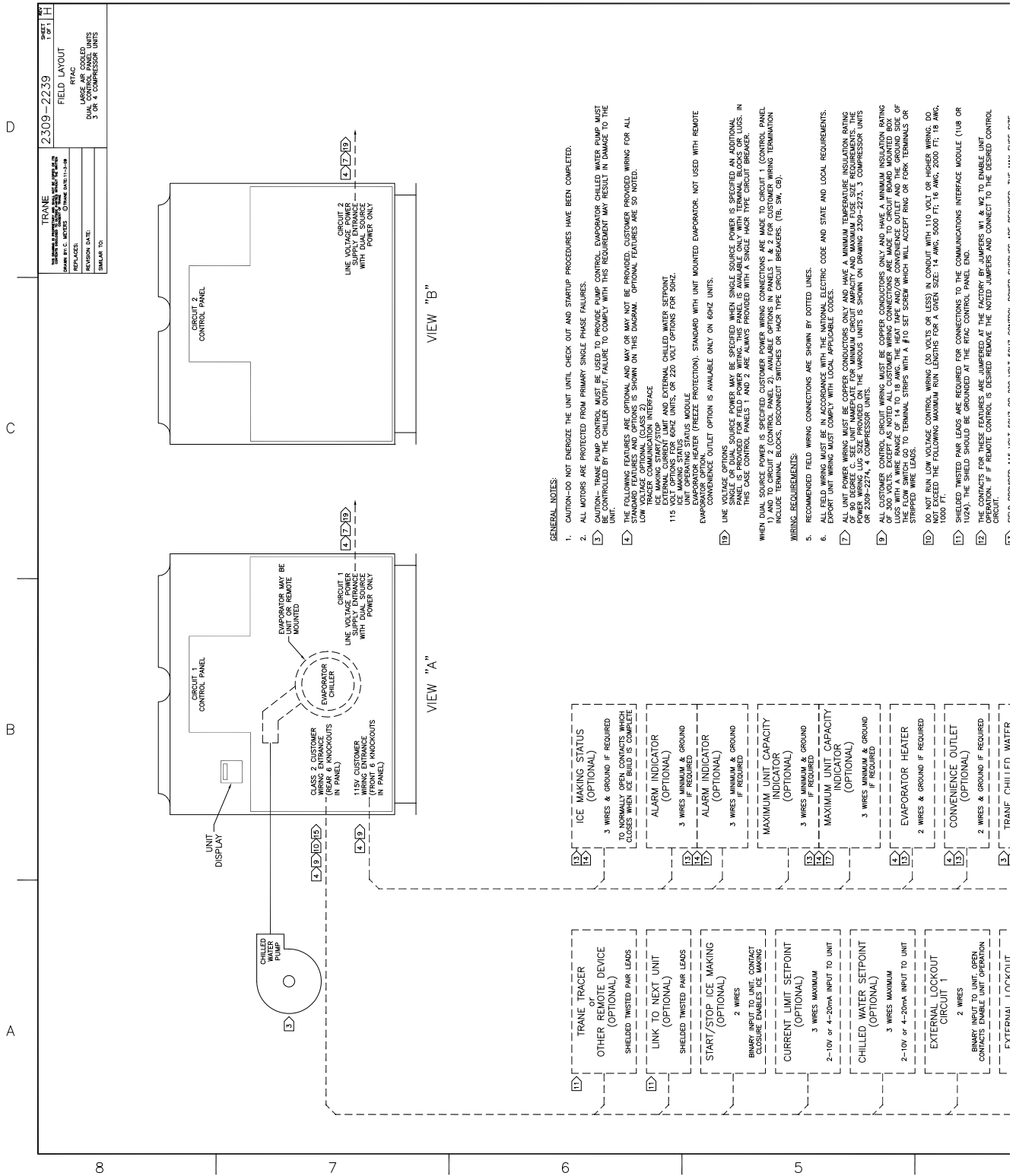

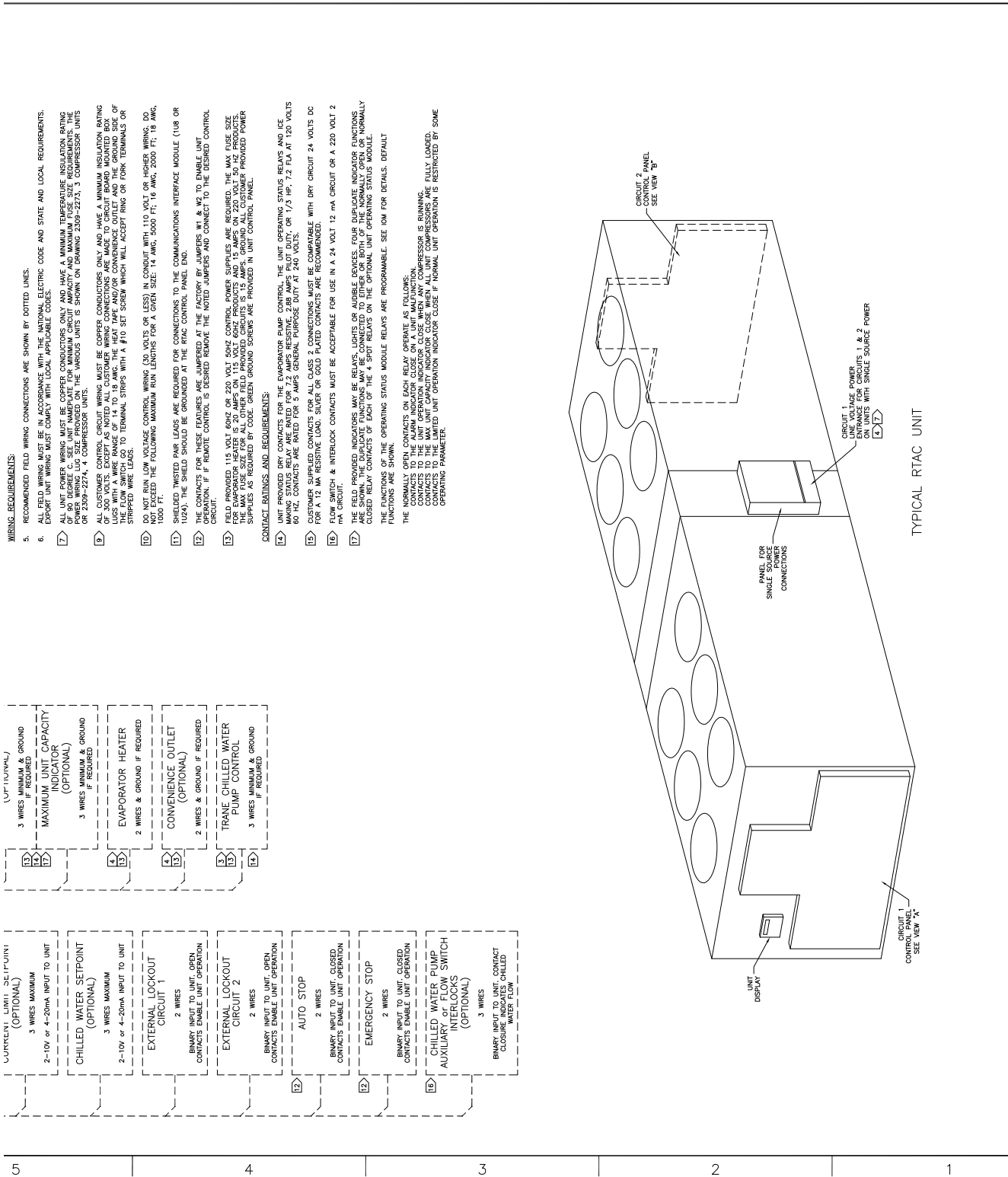

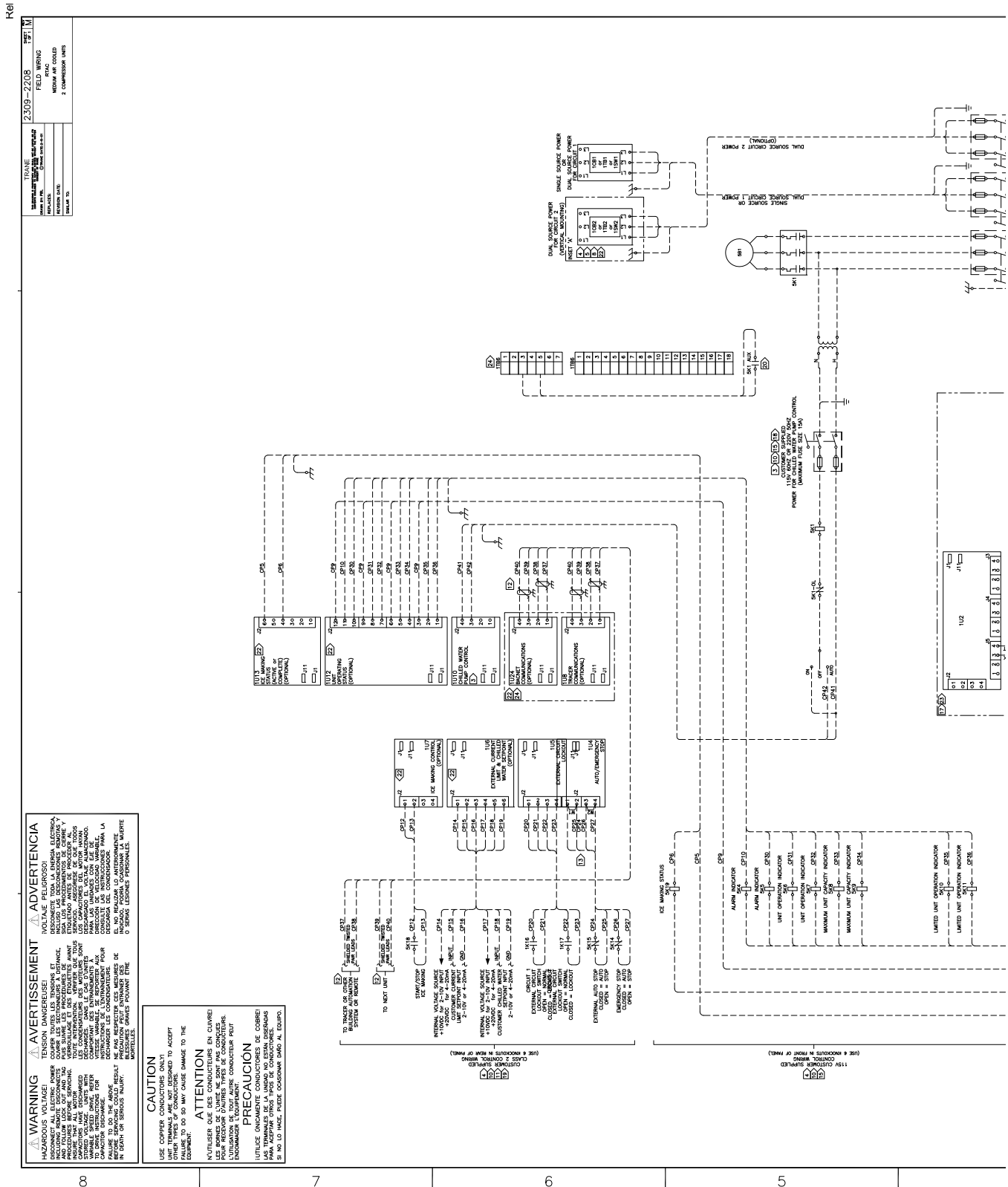

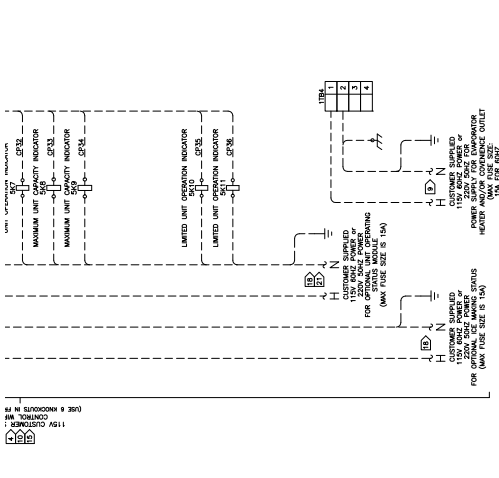
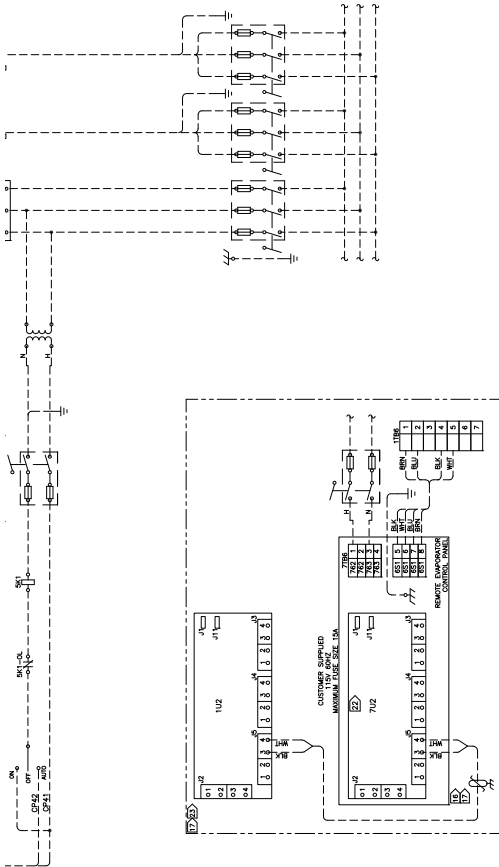

GENERAL NOTES:

- CAUTION-DO NOT ENERGIZE THE UNIT, CHECK OUT AND STARTUP PROCEDURES HAVE BEEN COMPLETED.
- ALL WIRING IS INSTALLED FROM PRIMARY SINGLE PHASE FEEDERS.
- WIRING SHALL BE INSTALLED IN ACCORDANCE WITH THE NATIONAL ELECTRICAL CODE AND STATE AND LOCAL REQUIREMENTS. EXPLORE UNIT REQUIREMENTS SHALL BE CONTROLLED BY THE CALLED OUT PARTS. EXPLORE UNIT REQUIREMENTS SHALL BE CONTROLLED BY THE CALLED OUT PARTS. FAILURE TO COMPLY WITH THIS REQUIREMENT WILL VOID THE WARRANTY.
- THE FOLLOWING TABLES ARE FOR INFORMATION ONLY. MAXIMUM FUSE SIZE REQUIREMENTS FOR ALL STANDARD REFRIGERANTS AND OPTIONS ARE SHOWN ON THE DIAGRAM. OPTIONS FEATURES ARE SO NOTED.
- LOW VOLTAGE CIRCUITS SHALL BE SEPARATE FROM OTHER BUILDING AUTOMATION SYSTEMS COMMUNICATION NETWORKS.
- OPTIONAL DISCONNECT SWITCH AND EXTERNAL CHILLED WATER SENSOR.
- 115 VOLT OPTIONS FOR 60HZ UNITS OR 230 VOLT OPTIONS FOR 50HZ UNITS.
- UNIT WIRING SHALL BE INSTALLED IN ACCORDANCE WITH THE NATIONAL ELECTRICAL CODE AND STATE AND LOCAL REQUIREMENTS. EXPLORE UNIT REQUIREMENTS SHALL BE CONTROLLED BY THE CALLED OUT PARTS. EXPLORE UNIT REQUIREMENTS SHALL BE CONTROLLED BY THE CALLED OUT PARTS. FAILURE TO COMPLY WITH THIS REQUIREMENT WILL VOID THE WARRANTY.
- UNIT WIRING SHALL BE INSTALLED IN ACCORDANCE WITH THE NATIONAL ELECTRICAL CODE AND STATE AND LOCAL REQUIREMENTS. EXPLORE UNIT REQUIREMENTS SHALL BE CONTROLLED BY THE CALLED OUT PARTS. EXPLORE UNIT REQUIREMENTS SHALL BE CONTROLLED BY THE CALLED OUT PARTS. FAILURE TO COMPLY WITH THIS REQUIREMENT WILL VOID THE WARRANTY.

REPLACEMENT FUSE SIZES	DESIGNATION	VOLTS	CLASS	AMPS
CONSIDERED	1T1 THRU 1T12	600	CC	10
	1T1 THRU 1T12	600	CC	15
	1T1 THRU 1T12	600	CC	20
	1T1 THRU 1T12	600	CC	25
	1T1 THRU 1T12	600	CC	30
	1T1 THRU 1T12	600	CC	35
	1T1 THRU 1T12	600	CC	40
	1T1 THRU 1T12	600	CC	45
	1T1 THRU 1T12	600	CC	50
	1T1 THRU 1T12	600	CC	55
	1T1 THRU 1T12	600	CC	60
	1T1 THRU 1T12	600	CC	65
	1T1 THRU 1T12	600	CC	70
	1T1 THRU 1T12	600	CC	75
	1T1 THRU 1T12	600	CC	80
	1T1 THRU 1T12	600	CC	85
	1T1 THRU 1T12	600	CC	90
	1T1 THRU 1T12	600	CC	95
	1T1 THRU 1T12	600	CC	100

WIRE SIZE RANGE FOR FACTORY PROVIDED LUGS FOR CUSTOMER POWER WIRING CONNECTIONS

VOLTAGE	SINGLE SOURCE POWER ELECTRICAL CIRCUIT 1 & 2		ELECTRICAL CIRCUIT 1 DUAL SOURCE POWER	
	UNIT SIZE (TONS)	LUG WIRE SIZE RANGE	UNIT SIZE (TONS)	LUG WIRE SIZE RANGE
200/60/3	140, 150, 175, 195, 225, 250	THREE 1/2 AMP - 500 MCM	140, 150, 175, 195, 225, 250	THREE 3/2 AMP - 500 MCM
230/60/3	140, 150, 175, 195, 225, 250	FOUR 3/8 AMP - 500 MCM	140, 150, 175, 195, 225, 250	THREE 1/2 AMP - 500 MCM
380/60/3	140, 150, 175, 195, 225, 250	FOUR 3/8 AMP - 500 MCM	140, 150, 175, 195, 225, 250	THREE 1/2 AMP - 500 MCM
460/60/3	140, 150, 175, 195, 225, 250	FOUR 3/8 AMP - 500 MCM	140, 150, 175, 195, 225, 250	THREE 1/2 AMP - 500 MCM
575/60/3	140, 150, 175, 195, 225, 250	FOUR 3/8 AMP - 500 MCM	140, 150, 175, 195, 225, 250	THREE 1/2 AMP - 500 MCM
600/60/3	140, 150, 175, 195, 225, 250	FOUR 3/8 AMP - 500 MCM	140, 150, 175, 195, 225, 250	THREE 1/2 AMP - 500 MCM

DISCONNECT SWITCH OPTION

VOLTAGE	SINGLE SOURCE POWER ELECTRICAL CIRCUIT 1 & 2		ELECTRICAL CIRCUIT 1 DUAL SOURCE POWER	
	UNIT SIZE (TONS)	LUG WIRE SIZE RANGE	UNIT SIZE (TONS)	LUG WIRE SIZE RANGE
200/60/3	140, 150, 175, 195, 225, 250	FOUR 3/8 AMP - 500 MCM	140, 150, 175, 195, 225, 250	THREE 1/2 AMP - 500 MCM
230/60/3	140, 150, 175, 195, 225, 250	FOUR 3/8 AMP - 500 MCM	140, 150, 175, 195, 225, 250	THREE 1/2 AMP - 500 MCM
380/60/3	140, 150, 175, 195, 225, 250	FOUR 3/8 AMP - 500 MCM	140, 150, 175, 195, 225, 250	THREE 1/2 AMP - 500 MCM
460/60/3	140, 150, 175, 195, 225, 250	FOUR 3/8 AMP - 500 MCM	140, 150, 175, 195, 225, 250	THREE 1/2 AMP - 500 MCM
575/60/3	140, 150, 175, 195, 225, 250	FOUR 3/8 AMP - 500 MCM	140, 150, 175, 195, 225, 250	THREE 1/2 AMP - 500 MCM
600/60/3	140, 150, 175, 195, 225, 250	FOUR 3/8 AMP - 500 MCM	140, 150, 175, 195, 225, 250	THREE 1/2 AMP - 500 MCM

TERMINAL BLOCK OR LUG OPTION

VOLTAGE	SINGLE SOURCE POWER ELECTRICAL CIRCUIT 1 & 2		ELECTRICAL CIRCUIT 1 DUAL SOURCE POWER	
	UNIT SIZE (TONS)	LUG WIRE SIZE RANGE	UNIT SIZE (TONS)	LUG WIRE SIZE RANGE
200/60/3	140, 150, 175, 195, 225, 250	THREE 1/2 AMP - 600 MCM	140, 150, 175, 195, 225, 250	THREE 3/2 AMP - 600 MCM
230/60/3	140, 150, 175, 195, 225, 250	THREE 1/2 AMP - 600 MCM	140, 150, 175, 195, 225, 250	THREE 3/2 AMP - 600 MCM
380/60/3	140, 150, 175, 195, 225, 250	THREE 1/2 AMP - 600 MCM	140, 150, 175, 195, 225, 250	THREE 3/2 AMP - 600 MCM
460/60/3	140, 150, 175, 195, 225, 250	THREE 1/2 AMP - 600 MCM	140, 150, 175, 195, 225, 250	THREE 3/2 AMP - 600 MCM
575/60/3	140, 150, 175, 195, 225, 250	THREE 1/2 AMP - 600 MCM	140, 150, 175, 195, 225, 250	THREE 3/2 AMP - 600 MCM
600/60/3	140, 150, 175, 195, 225, 250	THREE 1/2 AMP - 600 MCM	140, 150, 175, 195, 225, 250	THREE 3/2 AMP - 600 MCM

GENERAL NOTES:

- SINGLE SOURCE POWER IS PROVIDED AS STANDARD. DUAL SOURCE POWER IS AVAILABLE AS AN OPTION. (UNIT 1 & 2)
- RECOMMENDED FIELD WIRING CONNECTIONS ARE SHOWN BY DOTTED LINES
- ALL WIRING MUST BE IN ACCORDANCE WITH THE NATIONAL ELECTRICAL CODE AND STATE AND LOCAL REQUIREMENTS. EXPLORE UNIT REQUIREMENTS SHALL BE CONTROLLED BY THE CALLED OUT PARTS. EXPLORE UNIT REQUIREMENTS SHALL BE CONTROLLED BY THE CALLED OUT PARTS. FAILURE TO COMPLY WITH THIS REQUIREMENT WILL VOID THE WARRANTY.
- THE FOLLOWING TABLES ARE FOR INFORMATION ONLY. MAXIMUM FUSE SIZE REQUIREMENTS FOR ALL STANDARD REFRIGERANTS AND OPTIONS ARE SHOWN ON THE DIAGRAM. OPTIONS FEATURES ARE SO NOTED.
- LOW VOLTAGE CIRCUITS SHALL BE SEPARATE FROM OTHER BUILDING AUTOMATION SYSTEMS COMMUNICATION NETWORKS.
- OPTIONAL DISCONNECT SWITCH AND EXTERNAL CHILLED WATER SENSOR.
- 115 VOLT OPTIONS FOR 60HZ UNITS OR 230 VOLT OPTIONS FOR 50HZ UNITS.
- UNIT WIRING SHALL BE INSTALLED IN ACCORDANCE WITH THE NATIONAL ELECTRICAL CODE AND STATE AND LOCAL REQUIREMENTS. EXPLORE UNIT REQUIREMENTS SHALL BE CONTROLLED BY THE CALLED OUT PARTS. EXPLORE UNIT REQUIREMENTS SHALL BE CONTROLLED BY THE CALLED OUT PARTS. FAILURE TO COMPLY WITH THIS REQUIREMENT WILL VOID THE WARRANTY.
- UNIT WIRING SHALL BE INSTALLED IN ACCORDANCE WITH THE NATIONAL ELECTRICAL CODE AND STATE AND LOCAL REQUIREMENTS. EXPLORE UNIT REQUIREMENTS SHALL BE CONTROLLED BY THE CALLED OUT PARTS. EXPLORE UNIT REQUIREMENTS SHALL BE CONTROLLED BY THE CALLED OUT PARTS. FAILURE TO COMPLY WITH THIS REQUIREMENT WILL VOID THE WARRANTY.

Electrical Connection

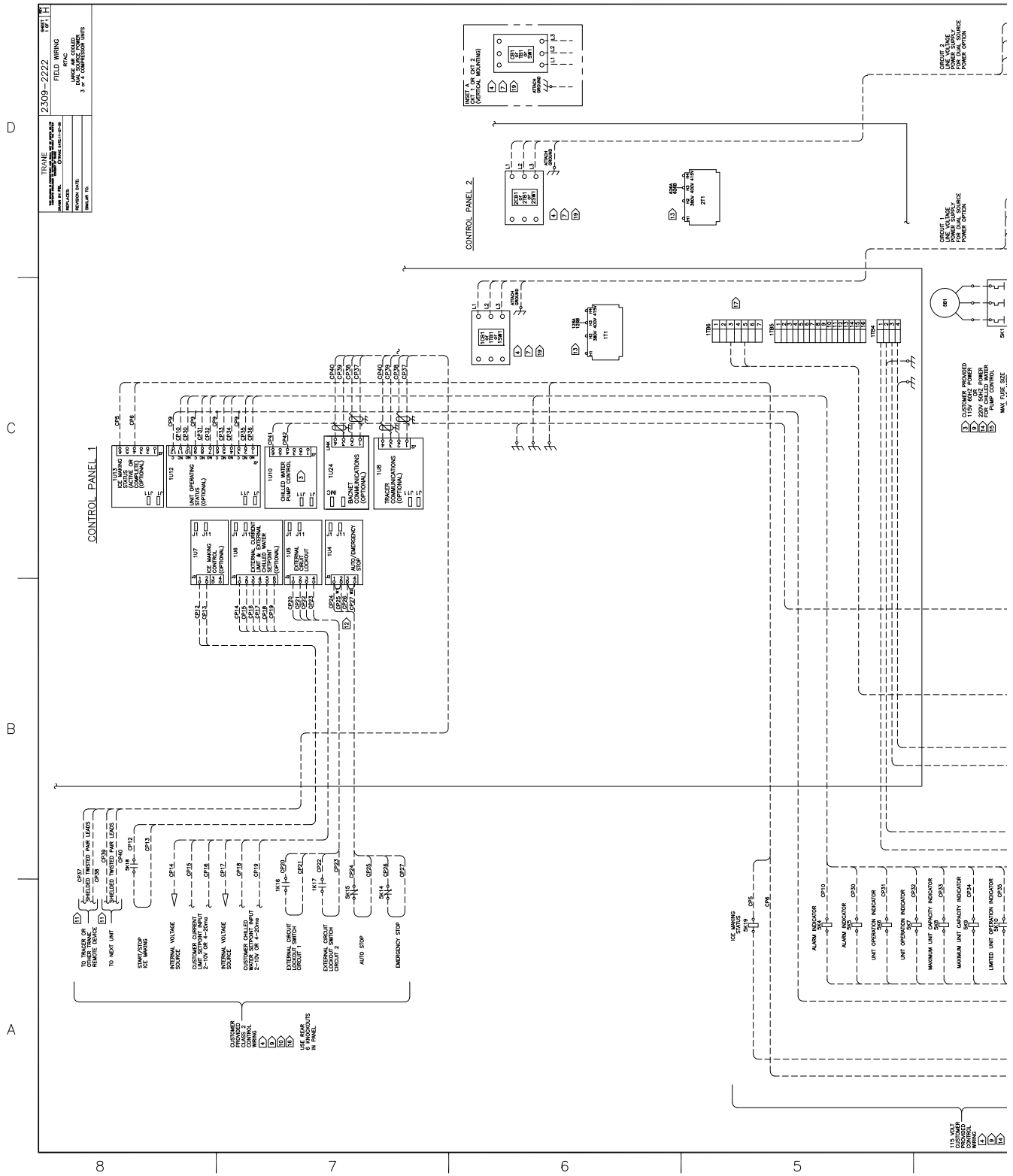

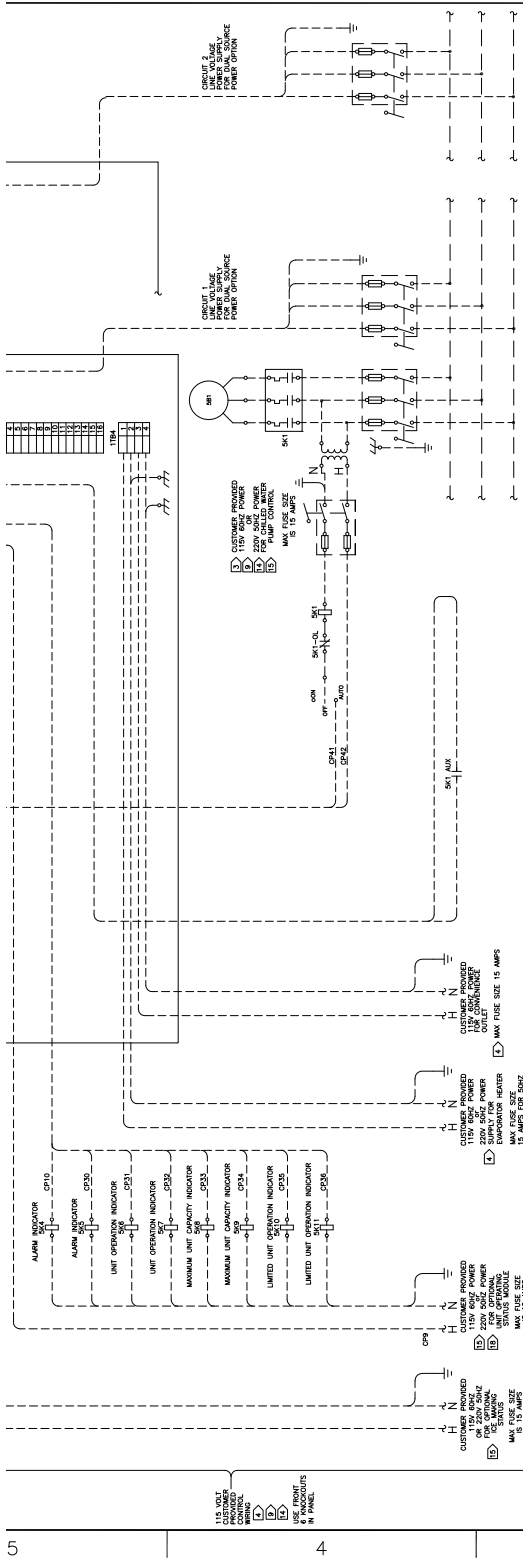

- ⊠ CUSTOMER PROVIDED 115V 1-PHASE POWER FOR 1-1/2 TON UNITS. MAX FUSE SIZE 15 AMPS.
- ⊠ CUSTOMER PROVIDED 230V 3-PHASE POWER FOR 2-1/2 TON UNITS. MAX FUSE SIZE 15 AMPS.
- ⊠ CUSTOMER PROVIDED 460V 3-PHASE POWER FOR 4-1/2 TON UNITS. MAX FUSE SIZE 15 AMPS.

- ⊠ 115V 1-PHASE POWER FOR 1-1/2 TON UNITS.
- ⊠ 230V 3-PHASE POWER FOR 2-1/2 TON UNITS.
- ⊠ 460V 3-PHASE POWER FOR 4-1/2 TON UNITS.

1. CAUTION-DO NOT ENERGIZE THE UNIT UNTIL CHECK OUT AND STARTUP PROCEDURES HAVE BEEN COMPLETED.
2. ALL MOTORS ARE PROTECTED FROM PRIMARY SINGLE PHASE FAILURES.
 - ⊠ ABAJUNDO TRAFICANTE EN LOS CONECTORES DE LOS MOTORES EN LA SECCION DE CONEXIONES DEL CONTROL PUEDEN SER USADOS PARA EL PUNTO DE MUESTRA DEL MONTAJE DEL MONTAJE EN LA SECCION DE CONEXIONES DEL CONTROL.
 - ⊠ THE CONNECTIONS OF THE MOTOR TERMINALS TO THE CONTROL MUST BE MADE IN THE SAME MANNER AS SHOWN IN THE WIRING FOR ALL STANDARD FEATURES AND OPTIONS AS SHOWN ON THE DIAGRAM. SPECIAL FEATURES ARE SO NOTED.
 - ⊠ LOW VOLTAGE CONTROL CIRCUIT WIRING MUST BE MADE IN ACCORDANCE WITH THE NATIONAL ELECTRICAL CODE.
3. RECOMMENDED FIELD WIRING CONNECTIONS ARE SHOWN BY DOTTED LINES.
4. ALL FIELD WIRING MUST BE IN ACCORDANCE WITH THE NATIONAL ELECTRICAL CODE AND STATE AND LOCAL REQUIREMENTS. EXPORT UNIT WIRING MUST COMPLY WITH LOCAL APPLICABLE CODES.
5. ALL CUSTOMER CONTROL WIRING MUST BE COPPER CONDUCTORS ONLY AND HAVE A MINIMUM INSULATION RATING OF 600 VOLTS PER LEAD. THE LEADS MUST BE WELDED TO THE TERMINALS OF THE CONTROL PANEL. THE MINIMUM LENGTH OF THE LEADS MUST BE 14 IN. AND THE MAXIMUM LENGTH OF THE LEADS MUST BE 18 IN. THE LEADS MUST HAVE AN OVER CURRENT PROTECTIVE DEVICE (OCPD) IN THE LEAD. THE OCPD MUST BE A FUSE OR CIRCUIT BREAKER WITH A 125% RATED CURRENT SETTING. THE WIRING UNITS 2500-2515, 3 COMPRESSOR UNITS OR 2500-2575, 3 COMPRESSOR UNITS.
 - ⊠ DO NOT RUN LOW VOLTAGE CONTROL WIRING (50 VOLTS OR LESS) IN CONDUIT WITH 110 VOLT OR HIGHER WIRING. DO NOT RUN THE FOLLOWING WIRING RUN LENGTHS FOR A GREN SIZE: 14 AWG, 3000 FT; 16 AWG, 2500 FT; 18 AWG, 1000 FT.
 - ⊠ SHIELDED WIRING AND LEADS ARE REQUIRED FOR CONNECTIONS TO THE COMMUNICATIONS INTERFACE MODULE (CIM) OR WIRELESS NETWORK DEVICE. THE LEADS MUST BE WELDED TO THE TERMINALS OF THE CONTROL PANEL. THE MINIMUM LENGTH OF THE LEADS MUST BE 14 IN. AND THE MAXIMUM LENGTH OF THE LEADS MUST BE 18 IN. THE LEADS MUST HAVE AN OVER CURRENT PROTECTIVE DEVICE (OCPD) IN THE LEAD. THE OCPD MUST BE A FUSE OR CIRCUIT BREAKER WITH A 125% RATED CURRENT SETTING. THE WIRING UNITS 2500-2515, 3 COMPRESSOR UNITS OR 2500-2575, 3 COMPRESSOR UNITS.
 - ⊠ ALL CUSTOMER CONTROL WIRING MUST BE COPPER CONDUCTORS ONLY AND HAVE A MINIMUM INSULATION RATING OF 600 VOLTS PER LEAD. THE LEADS MUST BE WELDED TO THE TERMINALS OF THE CONTROL PANEL. THE MINIMUM LENGTH OF THE LEADS MUST BE 14 IN. AND THE MAXIMUM LENGTH OF THE LEADS MUST BE 18 IN. THE LEADS MUST HAVE AN OVER CURRENT PROTECTIVE DEVICE (OCPD) IN THE LEAD. THE OCPD MUST BE A FUSE OR CIRCUIT BREAKER WITH A 125% RATED CURRENT SETTING. THE WIRING UNITS 2500-2515, 3 COMPRESSOR UNITS OR 2500-2575, 3 COMPRESSOR UNITS.
 - ⊠ AS SHOWN THE NORMAL 400 VOLT UNIT CONTROL WIRING TRANSFORMERS ARE WELDED ON THE 400 VOLT TAP (W1). TRANSFORMER LEADS 120A & 120B SHOULD BE RECONNECTED TO THE APPROPRIATE TAP FOR THE 300 (U2) OR 415 (U3) VOLTAGE. THE LEADS SHOULD BE RECONNECTED TO THE APPROPRIATE TAP FOR THE 300 (U2) OR 415 (U3) VOLTAGE.
 - ⊠ GROUND ALL CUSTOMER PROVIDED 115 VOLT POWER SUPPLIES AS REQUIRED BY CODES. GREEN GROUND SCHEMAS ARE PROVIDED IN THE UNIT CONTROL PANEL.
6. CONTACT RATINGS AND REQUIREMENTS
 - ⊠ ALL WIRING AND CONNECTIONS MUST BE MADE IN ACCORDANCE WITH THE NATIONAL ELECTRICAL CODE (NEC) OR IEC. THE CONTACT RATINGS ARE AS FOLLOWS:

CONTACT RATINGS	UNIT VOLTAGE	DESCRIPTION	WALTER CLASS	AMP
CONDENSER FANS	115	115-117/2121-2123		10
	230			8
	460			5
	600		CC	5
CONTROL POWER TRANSFORMER - PRIMARY		115/117/171/213/214		10
				5
CONTROL POWER TRANSFORMER - SECONDARY		115/2125		10
		117/2126-2127		5
HEATING LINE AND/OR INVERTER TRANSFORMER - PRIMARY		117B-1122/2128-2129		10
				5
 - ⊠ CONTACT RATINGS ARE IN AMPERES. THE CONTACTS ARE MADE OF COPPER AND BRASS WITH A MINIMUM INSULATION RATING OF 600 VOLTS PER LEAD. THE CONTACTS ARE WELDED TO THE TERMINALS OF THE CONTROL PANEL.
 - ⊠ THE CONTACTS FOR EACH CONTACT ARE WELDED TO THE MOTOR WIRING AND CONNECT TO THE DESIRED CONTROL FUNCTION.
 - ⊠ AS SHOWN THE NORMAL 400 VOLT UNIT CONTROL WIRING TRANSFORMERS ARE WELDED ON THE 400 VOLT TAP (W1). TRANSFORMER LEADS 120A & 120B SHOULD BE RECONNECTED TO THE APPROPRIATE TAP FOR THE 300 (U2) OR 415 (U3) VOLTAGE. THE LEADS SHOULD BE RECONNECTED TO THE APPROPRIATE TAP FOR THE 300 (U2) OR 415 (U3) VOLTAGE.
 - ⊠ GROUND ALL CUSTOMER PROVIDED 115 VOLT POWER SUPPLIES AS REQUIRED BY CODES. GREEN GROUND SCHEMAS ARE PROVIDED IN THE UNIT CONTROL PANEL.

CAUTION
 USE COPPER CONDUCTORS ONLY!
 UNIT TERMINALS ARE NOT DESIGNED TO ACCEPT
 ALUMINUM WIRING. FAILURE TO DO SO MAY CAUSE DAMAGE TO THE
 EQUIPMENT.

ATTENTION
 NUNCA USAR ALAMBRE DE ALUMINIO EN LAS CLAVES
 DE LOS TERMINALES DEL UNIDAD. EL USO DE ALAMBRE
 DE ALUMINIO PUEDE RESULTAR EN DAÑO O FALLA DEL
 EQUIPAMIENTO.

PRECAUCIÓN
 NUNCA UTILICE CONDUCTORES DE ALUMINIO EN LAS CLAVES
 PARA ASIR OTROS TIPOS DE CONDUCTORES.
 EL USO DE ALUMINIO PUEDE RESULTAR EN DAÑO O FALLA DEL
 EQUIPAMIENTO.

WARNING
 HAZARDOUS VOLTAGE!
 DISCONNECT ALL ELECTRIC POWER FROM THE UNIT BEFORE ATTEMPTING TO SERVICE.
 FOLLOW LOCK OUT AND TAG PROCEDURES FOR ALL ELECTRICAL WORK. CAUTION: WIRE TERMINALS ARE NOT DESIGNED TO ACCEPT ALUMINUM WIRING. FAILURE TO DO SO MAY RESULT IN DAMAGE TO THE EQUIPMENT.
 PAUSE TO DO THE WORK BEFORE ANY OTHER PERSONS ENTER THE WORK AREA.
 SERVICIOS DE ALTA TENSION PUEDEN RESULTAR EN DAÑO O FALLA DEL EQUIPAMIENTO.

AVERTISSEMENT
 TENSION DANGEREUSE!
 COUPEZ LE COURANT ELECTRIQUE DE L'UNITE AVANT D'ESSAYER DE REPARER L'EQUIPEMENT.
 RESPECTEZ LES PROCEDURES DE VERIFICATION ET DE TAG POUR TOUS LES TRAVAUX ELECTRIQUES. LES TERMINALES DES CONDUCTEURS NE SONT PAS CONÇUES POUR ACCEPTER LE FIL D'ALUMINUM. LE NON RESPECT DE CE PRECAUTION PEUT RESULTER EN LA DEGRADATION DE L'EQUIPEMENT.
 NE PAS RESPECTER CES MESURES DE PRECAUTION PEUT RESULTER EN LA DEGRADATION DE L'EQUIPEMENT.

ADVERTENCIA
 DANGEROUS VOLTAGE!
 DISCONNECT ALL ELECTRIC POWER FROM THE UNIT BEFORE ATTEMPTING TO SERVICE.
 FOLLOW LOCK OUT AND TAG PROCEDURES FOR ALL ELECTRICAL WORK. CAUTION: WIRE TERMINALS ARE NOT DESIGNED TO ACCEPT ALUMINUM WIRING. FAILURE TO DO SO MAY RESULT IN DAMAGE TO THE EQUIPMENT.
 PAUSE TO DO THE WORK BEFORE ANY OTHER PERSONS ENTER THE WORK AREA.
 SERVICIOS DE ALTA TENSION PUEDEN RESULTAR EN DAÑO O FALLA DEL EQUIPAMIENTO.

- ⊠ UNIT TERMINALS ARE NOT DESIGNED TO ACCEPT ALUMINUM WIRING. FAILURE TO DO SO MAY CAUSE DAMAGE TO THE EQUIPMENT.
- ⊠ NUNCA USAR ALAMBRE DE ALUMINIO EN LAS CLAVES DE LOS TERMINALES DEL UNIDAD. EL USO DE ALAMBRE DE ALUMINIO PUEDE RESULTAR EN DAÑO O FALLA DEL EQUIPAMIENTO.
- ⊠ DISCONNECT ALL ELECTRIC POWER FROM THE UNIT BEFORE ATTEMPTING TO SERVICE. FOLLOW LOCK OUT AND TAG PROCEDURES FOR ALL ELECTRICAL WORK. CAUTION: WIRE TERMINALS ARE NOT DESIGNED TO ACCEPT ALUMINUM WIRING. FAILURE TO DO SO MAY RESULT IN DAMAGE TO THE EQUIPMENT.
- ⊠ PAUSE TO DO THE WORK BEFORE ANY OTHER PERSONS ENTER THE WORK AREA. SERVICIOS DE ALTA TENSION PUEDEN RESULTAR EN DAÑO O FALLA DEL EQUIPAMIENTO.
- ⊠ THE FUNCTIONS OF THE OPERATING STATUS MODULE RELAYS ARE PROGRAMMABLE. SEE OM FOR DETAILS. DEFAULT FUNCTIONS ARE SHOWN.
- ⊠ LINE VOLTAGE OPTIONS
 - ⊠ SINGLE OR DUAL SOURCE POWER MAY BE SPECIFIED. THE DIMMING COVERS THE DUAL SOURCE POWER OPTION.
 - ⊠ CUSTOMER PROVIDED 115V 1-PHASE POWER FOR 1-1/2 TON UNITS. MAX FUSE SIZE 15 AMPS.
 - ⊠ CUSTOMER PROVIDED 230V 3-PHASE POWER FOR 2-1/2 TON UNITS. MAX FUSE SIZE 15 AMPS.
 - ⊠ CUSTOMER PROVIDED 460V 3-PHASE POWER FOR 4-1/2 TON UNITS. MAX FUSE SIZE 15 AMPS.
- ⊠ LINE VOLTAGE OPTIONS
 - ⊠ SINGLE OR DUAL SOURCE POWER MAY BE SPECIFIED. THE DIMMING COVERS THE DUAL SOURCE POWER OPTION.
 - ⊠ CUSTOMER PROVIDED 115V 1-PHASE POWER FOR 1-1/2 TON UNITS. MAX FUSE SIZE 15 AMPS.
 - ⊠ CUSTOMER PROVIDED 230V 3-PHASE POWER FOR 2-1/2 TON UNITS. MAX FUSE SIZE 15 AMPS.
 - ⊠ CUSTOMER PROVIDED 460V 3-PHASE POWER FOR 4-1/2 TON UNITS. MAX FUSE SIZE 15 AMPS.

CONDENSER FANS	UNIT SIZE	UNIT VOLTAGE	DESCRIPTION	WALTER CLASS	AMP
	ALL	115	115-117/2121-2123		10
		230			8
		460			5
		600		CC	5
CONTROL POWER TRANSFORMER - PRIMARY	250 TON		115/117/171/213/214		10
					5
CONTROL POWER TRANSFORMER - SECONDARY	110		115/2125		10
			117/2126-2127		5
HEATING LINE AND/OR INVERTER TRANSFORMER - PRIMARY	500 TON		117B-1122/2128-2129		10
					5

Dimensions

120 HE/130 HE - 50 HZ
 140 SE/155 SE - 50/60HZ

WATER CONNECTION DIAMETER:

- 2 PASS 4" (100mm) NPS
- 3 PASS 3 1/2" (90mm) NPS

FAN IS NOT PRESENT
 ON 120 HE/140 SE

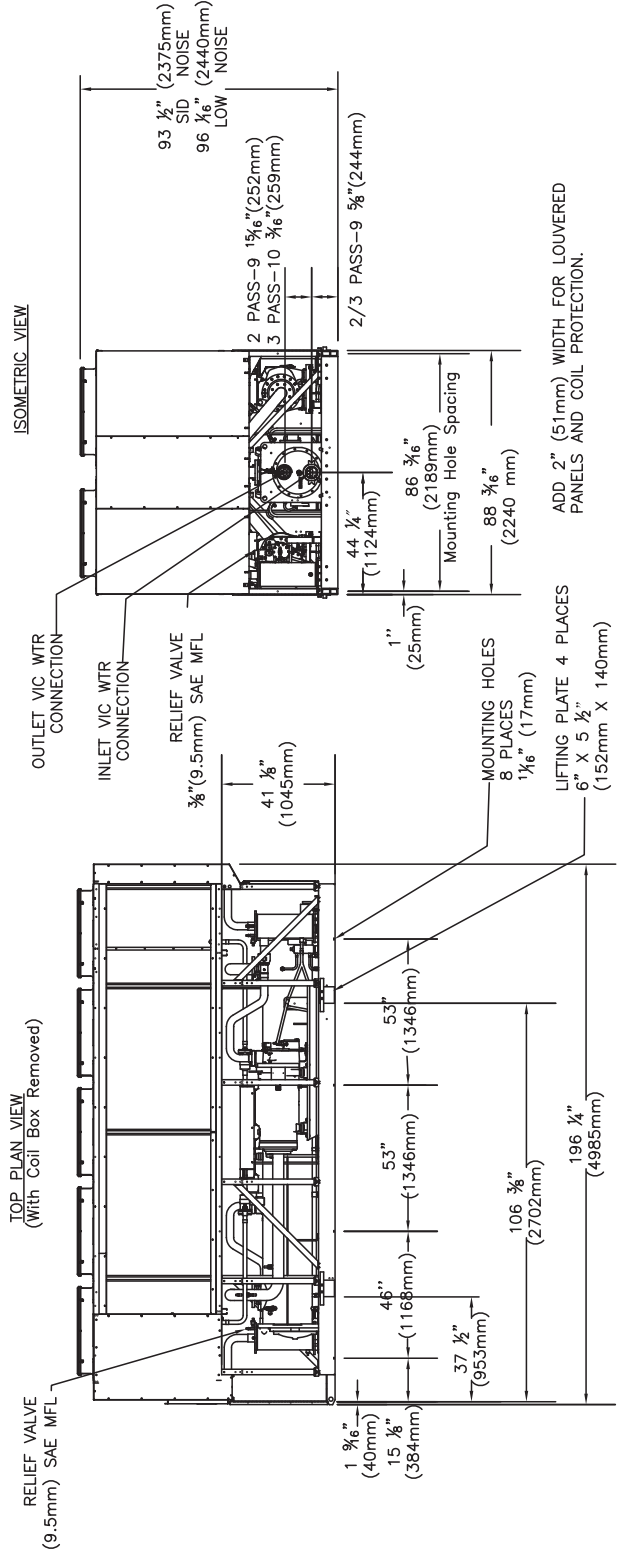
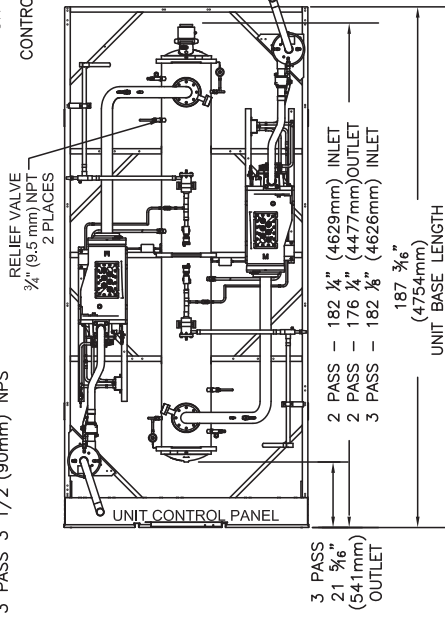
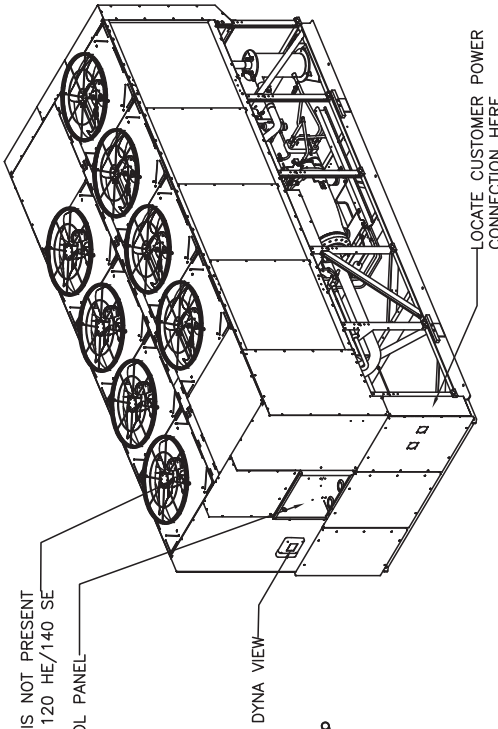

140 HE/170SE - 50 / 60HZ

WATER CONNECTION DIAMETER:
 2 PASS - 6" (150mm) NPS
 3 PASS - 4" (100mm) NPS

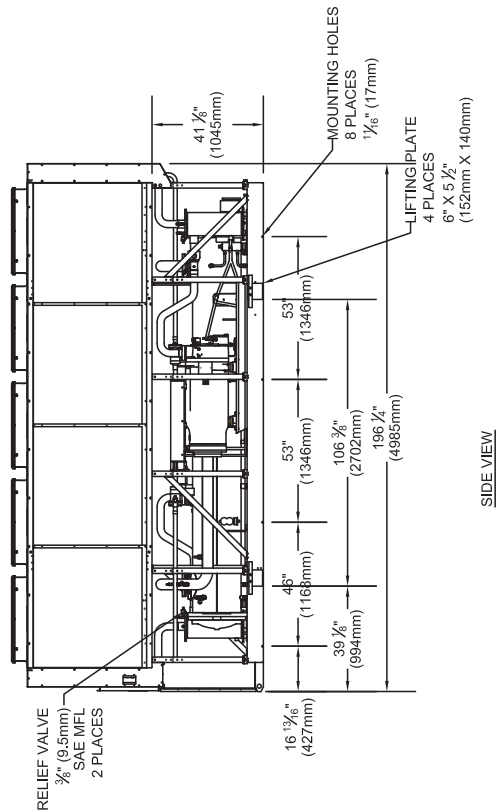
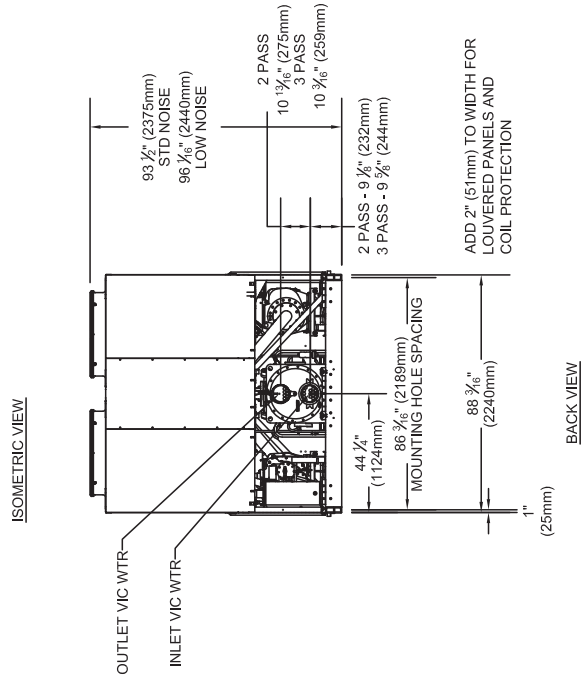
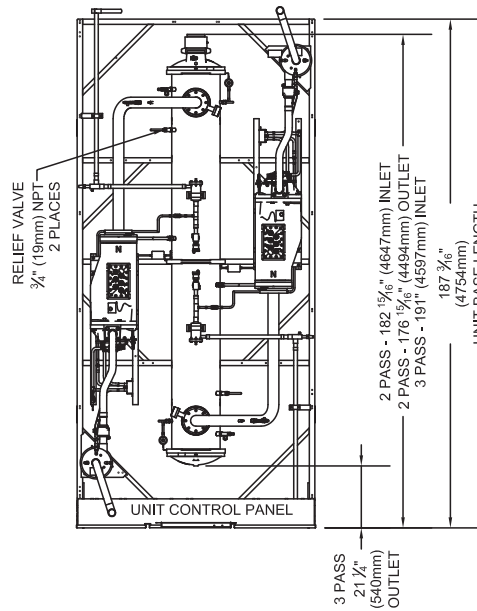
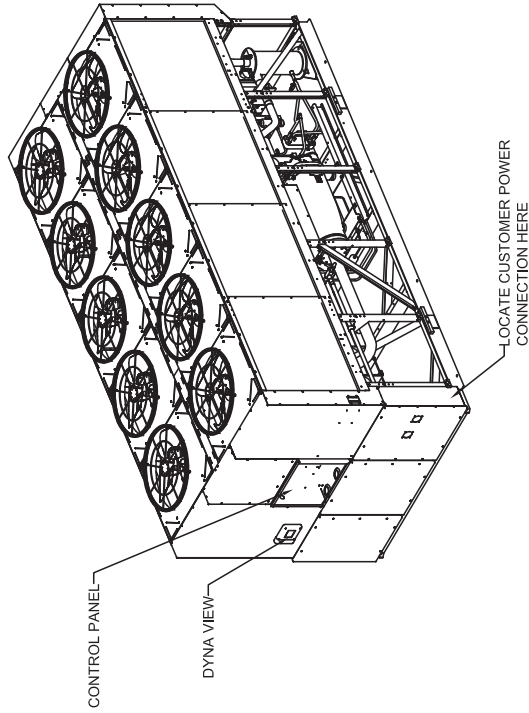

Dimensions

155, 170 HE/185, 200 SE - 50 / 60HZ
140 XE - 60 HZ

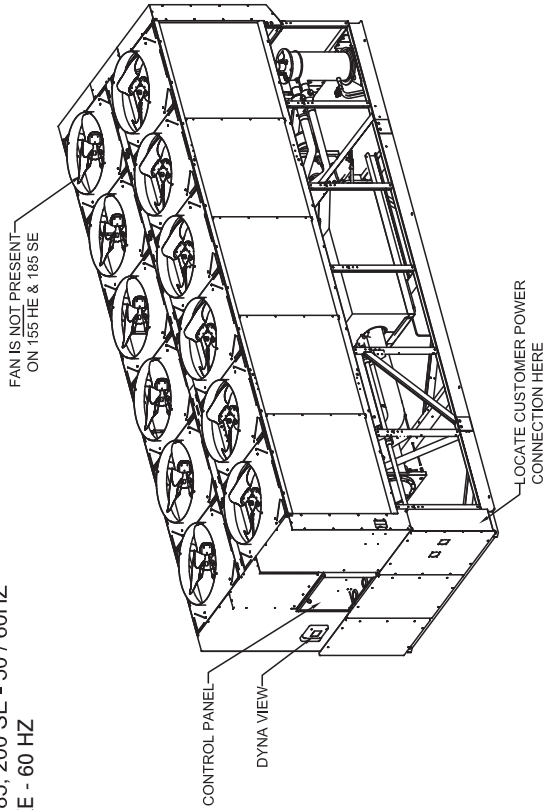

WATER CONNECTION DIAMETER:
2 PASS 6" (150mm) NPS
3 PASS 4" (100mm) NPS

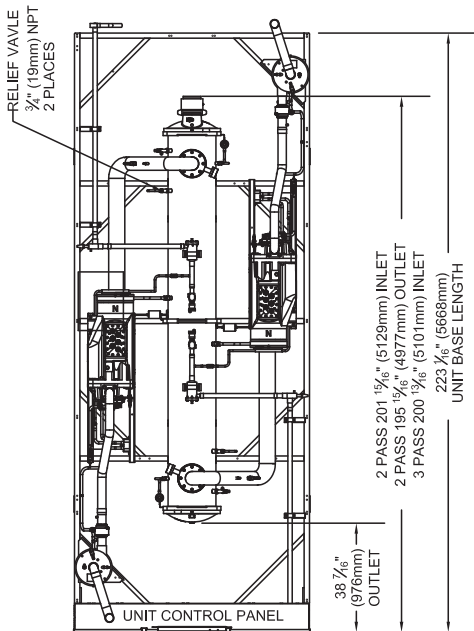

TOP PLAN VIEW (WITH COIL BOX REMOVED)

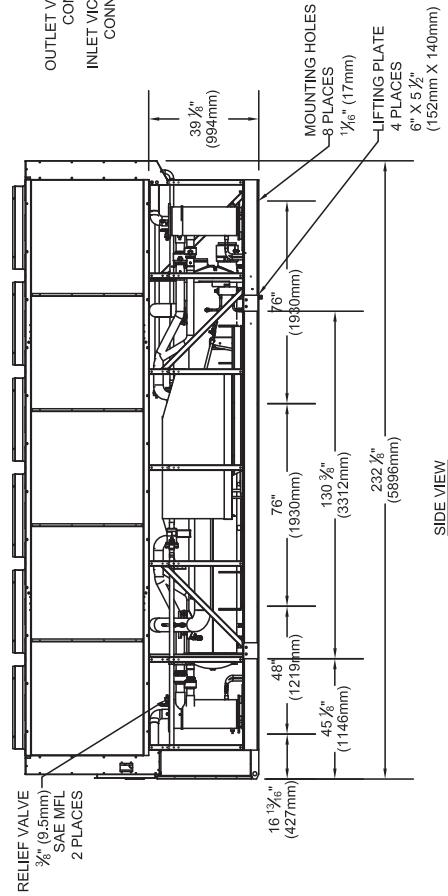

SIDE VIEW

ISOMETRIC VIEW

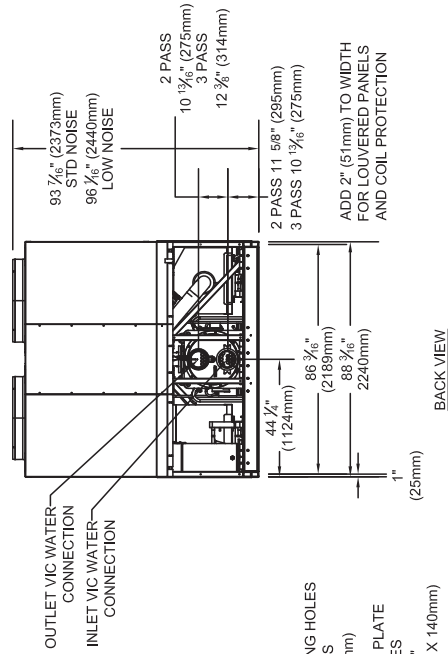

BACK VIEW

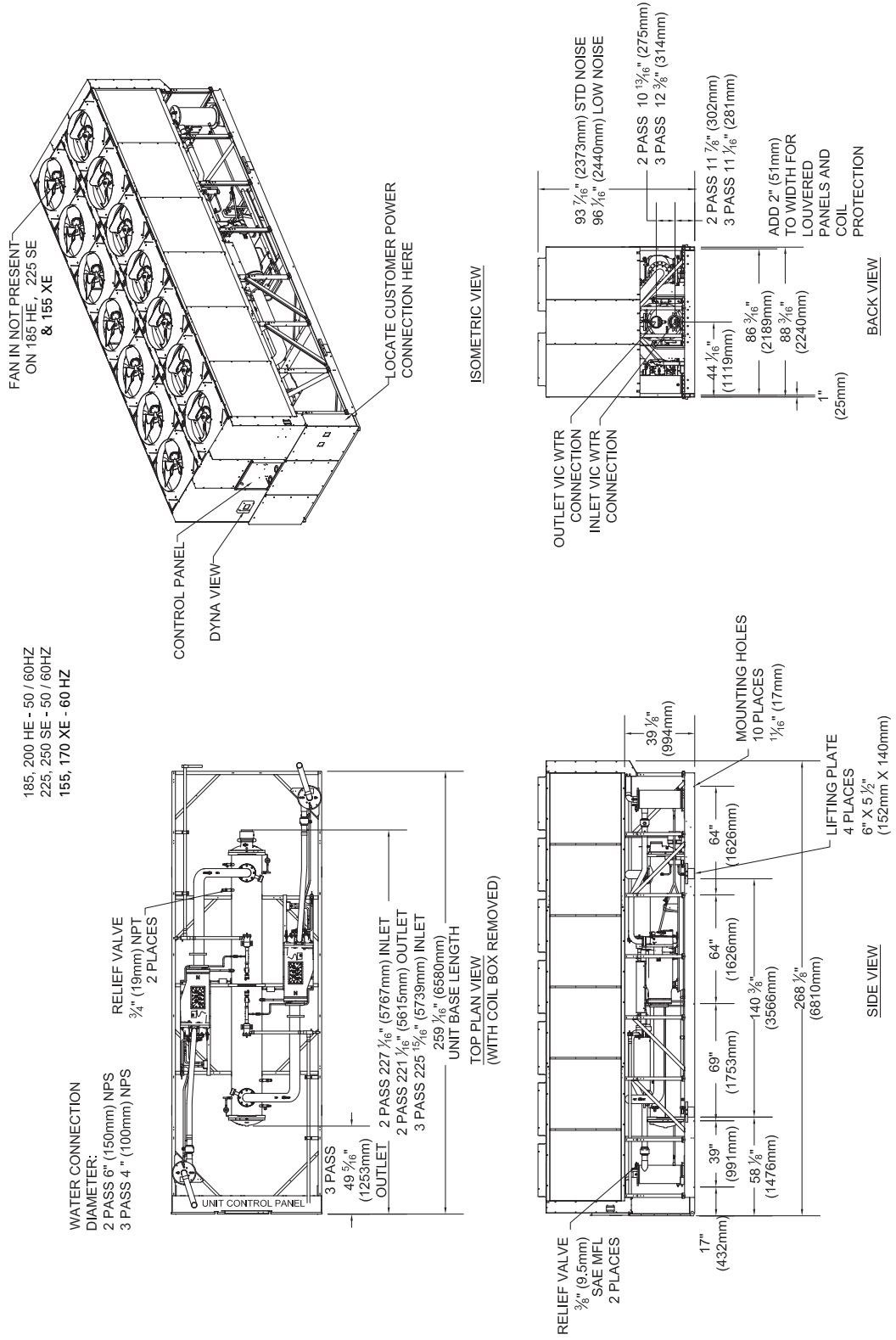

Dimensions

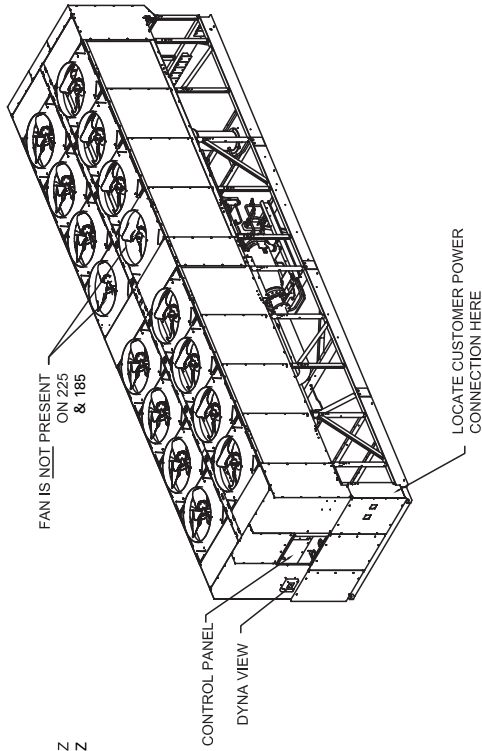

225 & 250 HE - 60 HZ
185 & 200 XE - 60 HZ

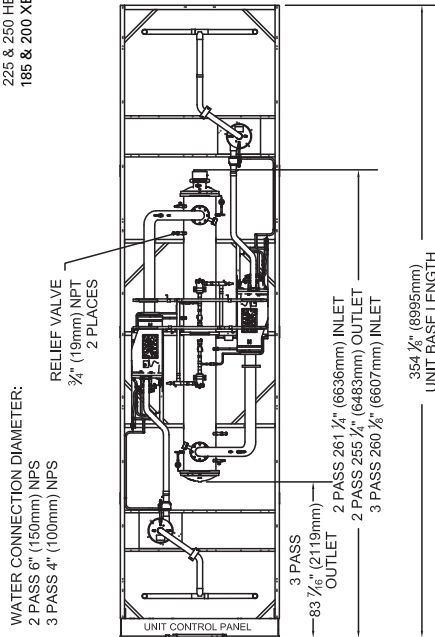

WATER CONNECTION DIAMETER:
2 PASS 6" (150mm) NPS
3 PASS 4" (100mm) NPS

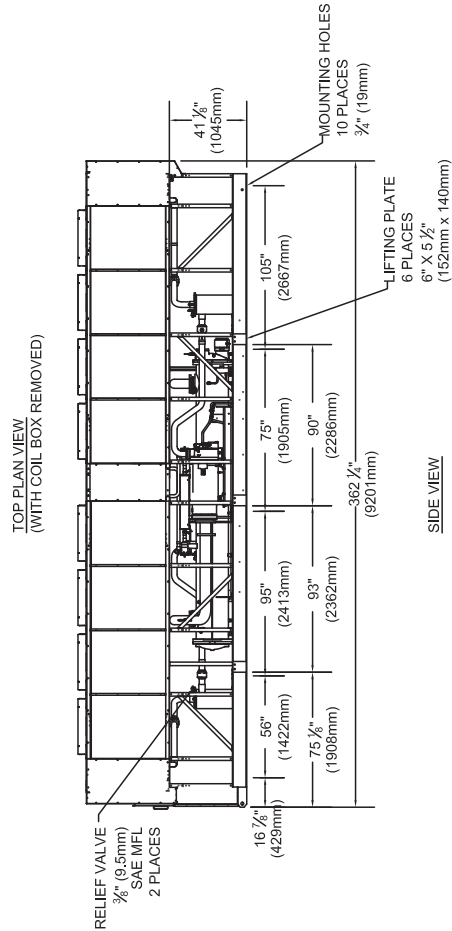
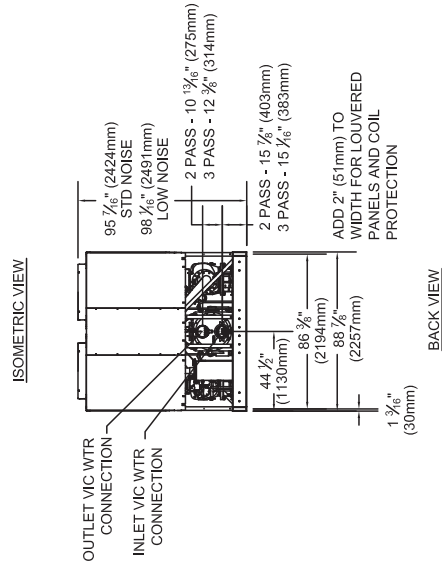

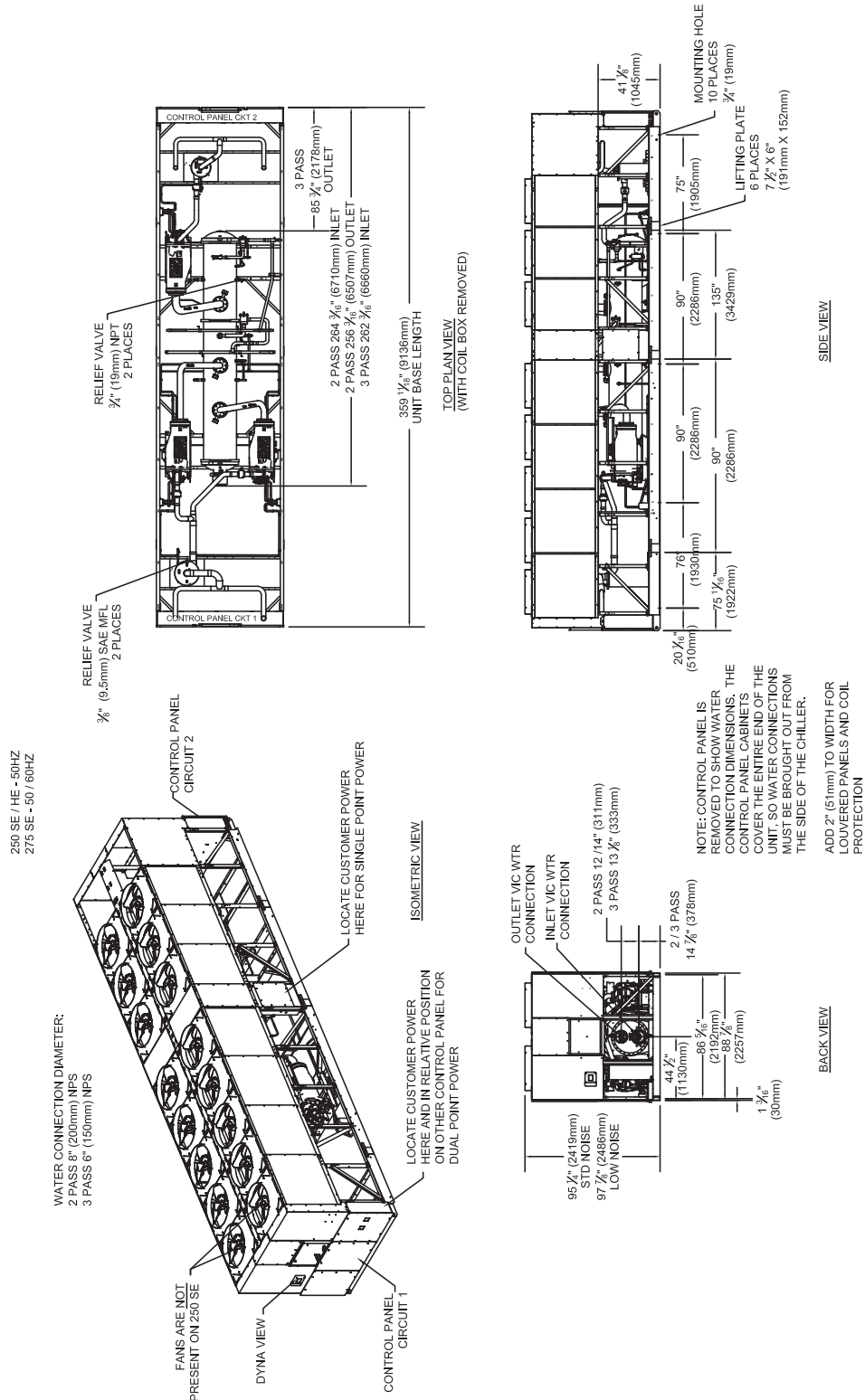

Dimensions

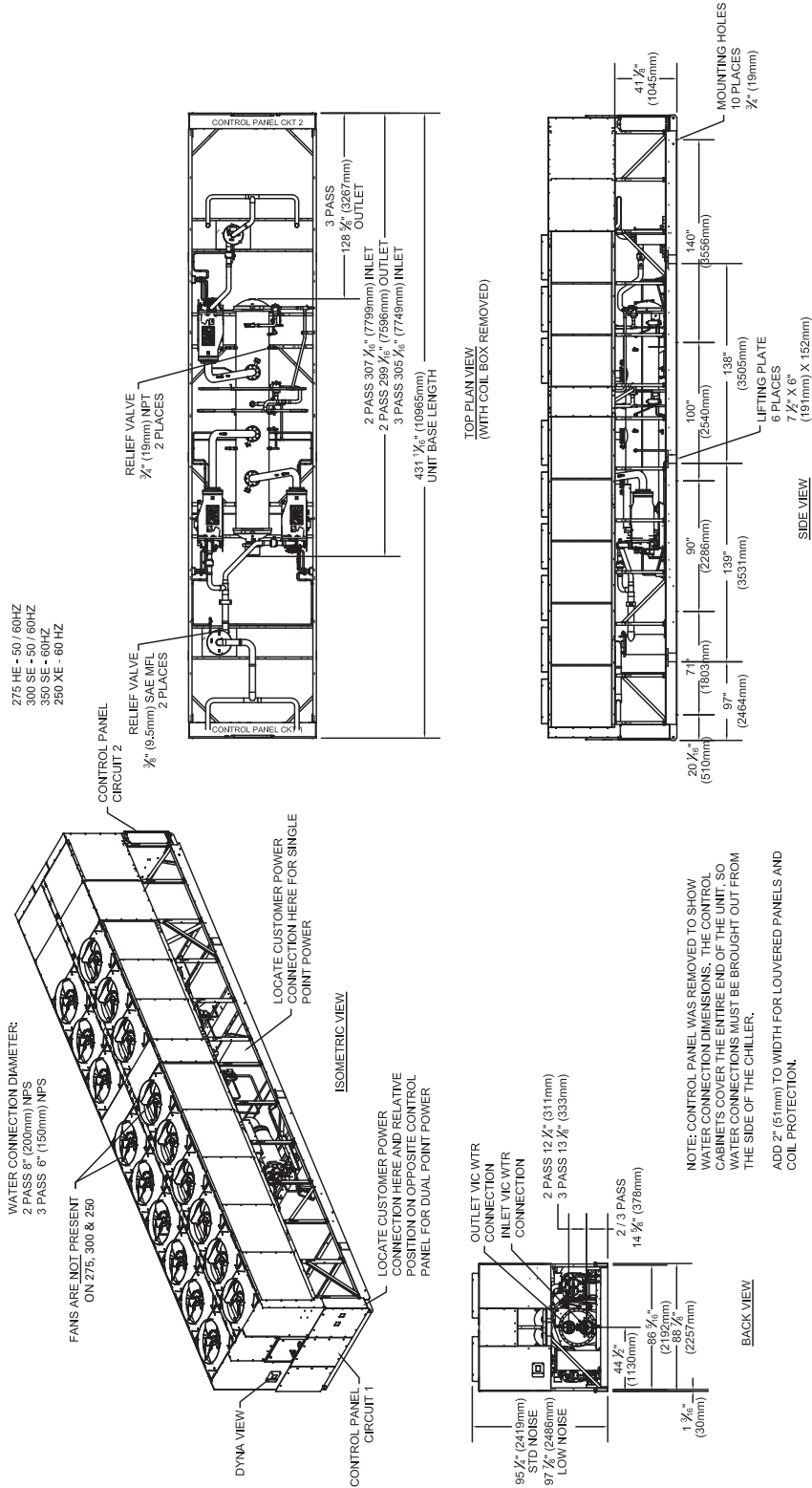

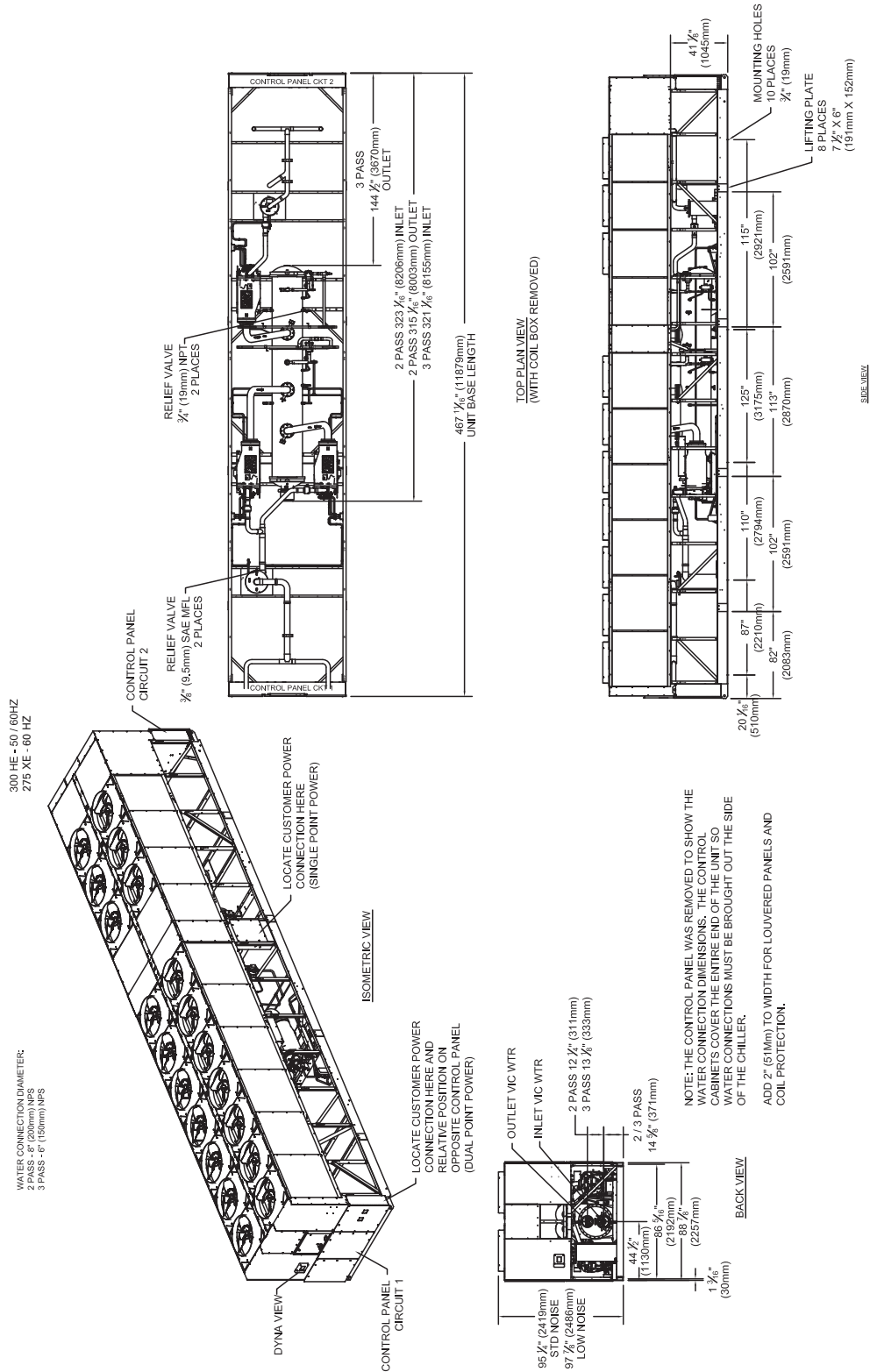

Dimensions

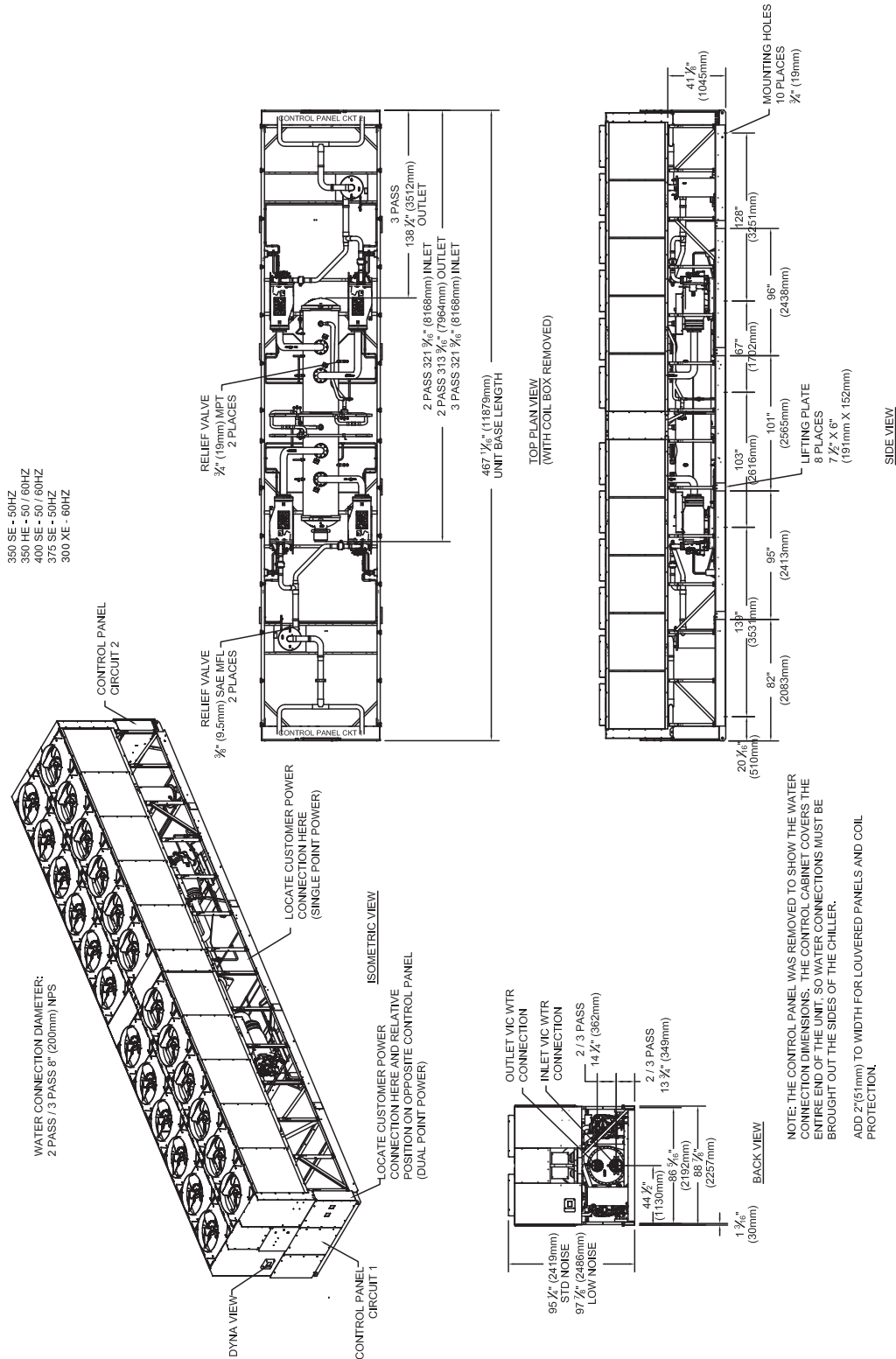

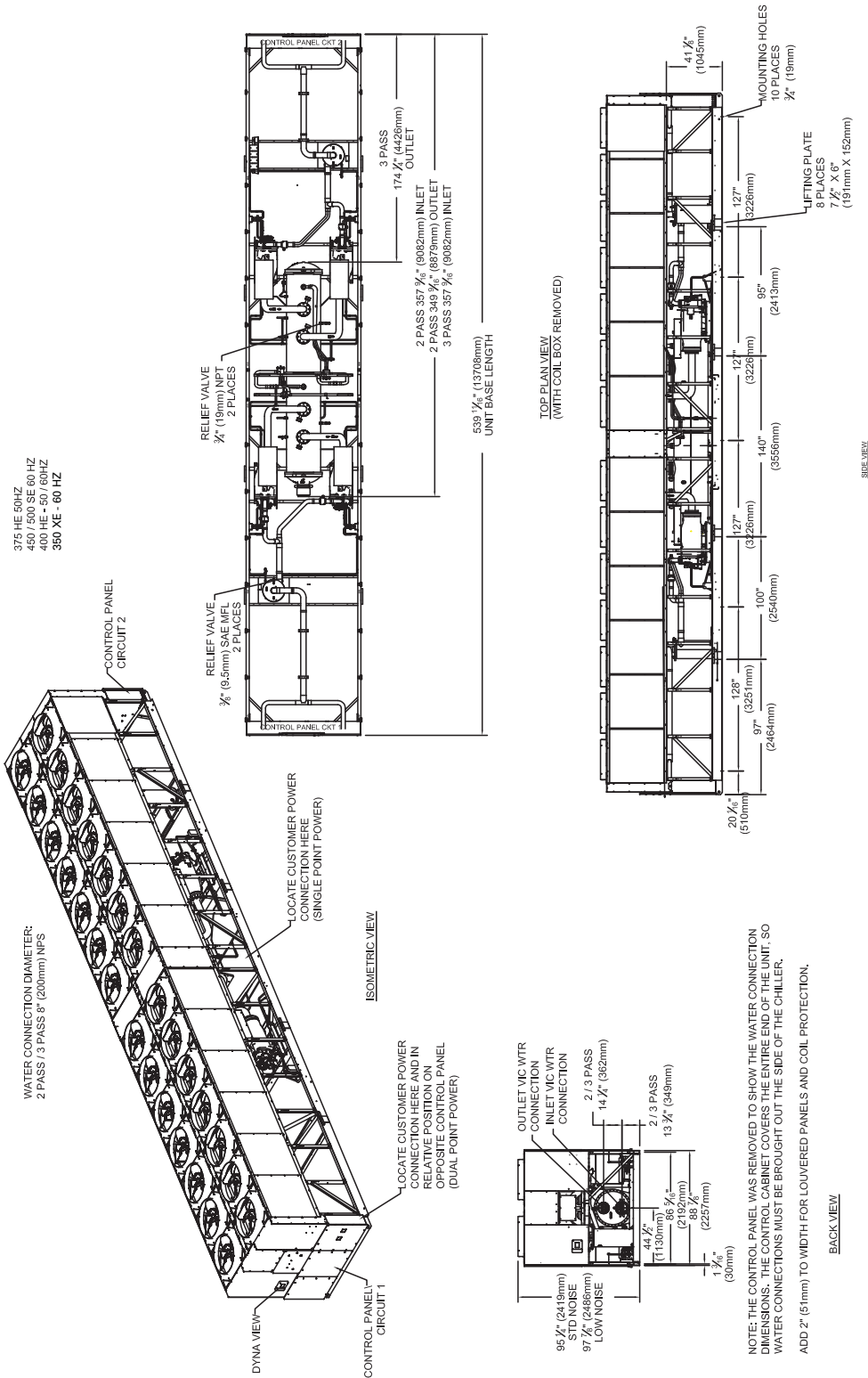



Weights

Weights

Table 1. Weight — packaged units — 60 Hz — aluminum or CompleteCoat coils

Unit Size (tons)	Standard Efficiency				High Efficiency				Extra Efficiency			
	Shipping		Operating		Shipping		Operating		Shipping		Operating	
	lb	kg	lb	kg	lb	kg	lb	kg	lb	kg	lb	kg
140	10831	4913	11077	5024	10858	4925	11140	5053	12172	5521	12557	5696
155	10910	4949	11113	5041	12114	5495	12414	5631	13983	6343	14306	6489
170	10868	4930	11205	5083	12172	5521	12557	5696	14434	6547	14698	6667
185	12478	5660	12892	5848	13983	6343	14306	6489	15906	7215	16382	7431
200	12885	5845	13208	5991	14434	6547	14698	6667	16006	7260	16351	7417
225	14905	6761	15224	6905	15906	7215	16382	7431	n/a			
250	14549	6599	14896	6757	16006	7260	16351	7417	19881	9018	20558	9325
275	18491	8387	19148	8685	19881	9018	20558	9325	21150	9593	21702	9844
300	20176	9152	20744	9409	21150	9593	21702	9844	23564	10688	24237	10994
350	21030	9539	21485	9745	23564	10688	24237	10994	26605	12068	27342	12402
400	24890	11290	25446	11542	26605	12068	27342	12402	n/a			
450	26310	11934	27005	12249	n/a				n/a			
500	26623	12076	27365	12413	n/a				n/a			

1. Operating weight includes refrigerant and water.
2. Shipping weight includes refrigerant.

Table 2. Weight — packaged units — 60 Hz — copper coils

Unit Size (tons)	Standard Efficiency				High Efficiency				Extra Efficiency			
	Shipping		Operating		Shipping		Operating		Shipping		Operating	
	lb	kg	lb	kg	lb	kg	lb	kg	lb	kg	lb	kg
140	13406	6081	13656	6194	13432	6093	13716	6221	15591	7072	15985	7251
155	13419	6087	13696	6212	15647	7097	15831	7181	18249	8278	18601	8437
170	13443	6098	13724	6225	15591	7072	15985	7251	18684	8475	18963	8601
185	15869	7198	16256	7374	18249	8278	18601	8437	20783	9427	21256	9642
200	16305	7396	16645	7550	18684	8475	18963	8601	20881	9471	21225	9628
225	18712	8488	19027	8631	20783	9427	21256	9642	n/a			
250	18897	8572	19160	8691	20881	9471	21225	9628	25505	11569	26072	11826
275	23370	10600	24095	10929	25505	11569	26072	11826	27078	12282	27724	12575
300	25681	11649	26212	11890	27078	12282	27724	12575	30341	13762	30968	14047
350	26894	12199	27400	12428	30341	13762	30968	14047	34482	15641	35280	16003
400	31708	14383	32315	14658	34482	15641	35280	16003	n/a			
450	32176	14595	32731	14847	n/a				n/a			
500	34502	15649	35254	15991	n/a				n/a			

1. Operating weight includes refrigerant and water.
2. Shipping weight includes refrigerant.

Mechanical Specifications

General

Units are leak and pressure tested at 390 psig high side, 250 psig low side, then evacuated and charged. All Air-Cooled Series R Chillers are factory tested prior to shipment. Packaged units ship with a full operating charge of oil and refrigerant. Unit panels, structural elements and control boxes are constructed of galvanized steel and mounted on a welded structural steel base. Unit panels and control boxes are finished with a baked on powder paint, and the structural base with an air dry paint. All paint meets the requirement for outdoor equipment of the US Navy and other federal government agencies.

Evaporator

The evaporator is a tube-in-shell heat exchanger design with internally and externally finned copper tubes roller expanded into the tube sheet. The evaporator is designed, tested and stamped in accordance with ASME for a refrigerant side working pressure of 200 psig. The evaporator is designed for a water side working pressure of 150 psig. Water connections are grooved pipe. Each shell includes a vent, a drain and fittings for temperature control sensors and is insulated with 3/4 inch equal insulation (K=0.26). Evaporator heaters with thermostat are provided to help protect the evaporator from freezing at ambient temperatures down to -20°F (-29°C). Factory installed flow switch is installed on a pipe stub in the evaporator inlet.

Condenser and Fans

Air-cooled condenser coils have aluminum fins mechanically bonded to internally finned seamless copper tubing. The condenser coil has an integral subcooling circuit. Condensers are factory proof and leak tested at 506 psig. Direct drive vertical discharge condenser fans are dynamically balanced. Totally enclosed air over motors completely seal the motor windings to prevent exposure to ambient conditions. Three-phase condenser fan motors with permanently lubricated ball bearings and internal thermal overload protection are provided. Standard units will start and operate between 25 to 115°F (-4 to 46°C) ambient.

Compressor and Lube Oil System

The rotary screw compressor is semi-hermetic, direct drive, 3600 rpm, 60 Hz, with capacity control slide valve, a load/unload valve, rolling element bearings, differential refrigerant pressure oil pump and oil heater. The motor is a suction gas cooled, hermetically sealed, two-pole squirrel cage induction motor. Oil separator and filtration devices are provided separate from the compressor. Check valves in the compressor discharge and lube oil system and a solenoid valve in the lube system are also provided.

Refrigeration Circuits

Each unit has two refrigerant circuits, with one or two rotary screw compressors per circuit. Each refrigerant circuit includes a compressor suction and discharge service valve, liquid line shutoff valve, removable core filter, liquid line sight glass with moisture indicator, charging port and an electronic expansion valve. Fully modulating compressors and electronic expansion valves provide variable capacity modulation over the entire operating range.

Unit Controls

All unit controls are housed in an outdoor rated weather tight enclosure with removable plates to allow for customer connection of power wiring and remote interlocks. All controls, including sensors, are factory mounted and tested prior to shipment. Microcomputer controls provide all control functions including startup and shut down, leaving chilled water temperature control, evaporator flow proving, compressor and electronic expansion valve modulation, fan sequencing, anti-recycle logic, automatic lead/lag compressor starting and load limiting. The unit control module, utilizing Adaptive Control™ microprocessor, automatically takes action to avoid unit shutdown due to abnormal operating conditions associated with low refrigerant pressure, high condensing pressure and motor current overload. Should the abnormal operating condition continue until a protective limit is violated, the unit will be shut down. Unit protective functions

Options

include loss of chilled water flow, evaporator freezing, loss of refrigerant, low refrigerant pressure, high refrigerant pressure, reverse rotation, compressor starting and running over current, phase loss, phase imbalance, phase reversal, and loss of oil flow. A digital display indicates chilled water setpoint and leaving chilled water temperature as standard. While current limit setpoint, evaporator and condenser refrigerant pressures, and electrical information are an option. Both standard and optional displays can be viewed on the unit without opening any control panel doors. Standard power connections include main three phase power to the compressors, condenser fans and control power transformer and optional connections are available for the 115 volt/60 Hz single phase power for freeze protection on the evaporator heaters.

Starters

Starters are housed in a weather tight enclosure with removable cover plate to allow for customer connection of power wiring. Across-the-line starters are standard on all 380-575/60 volt units. Wye Delta closed transition starters (33 percent of LRA inrush) are optional on 380-575/60 volt units and standard on 200-230/60 Hz volt units. Typically, Trane helical rotary screw compressors are up to full speed in one second when started across-the-line and have equivalent inrush with similar size reciprocating compressor with part wind starters.

Chilled Water Reset

This provides the control logic and factory installed sensors to reset leaving chilled water temperature. The setpoint can be reset based on ambient temperature or return evaporator water temperature.

Flow Control

The factory installed flow switch is provided with the control logic and relays to turn the chilled water flow on and off as the chiller requires for operation and protection. This function is a requirement on the Air-Cooled Series R Chiller.

Options

Applications Options

High Efficiency/Performance Option

High efficiency option provides an increase in efficiency over standard efficiency by providing oversized heat exchangers for two purposes. One, it allows the unit to be more energy efficient. Two, the unit will have enhanced operation in high ambient conditions.

Extra Efficiency/Performance Option

Extra efficiency option provides an increase in efficiency over the high efficiency unit by providing oversized heat exchangers for two purposes. One, it allows the unit to be more energy efficient. Two, the unit will have enhanced operation in high ambient conditions.

Ice Making

The ice making option provides special control logic and oil coolers to handle low temperature brine applications (less than 40°F [4.4°C] leaving evaporator temperature) for thermal storage applications.

Low Temperature Brine

The low temperature option provides special control logic and oil coolers to handle low temperature brine applications (less than 40°F [4.4°C] leaving evaporator temperature).

Low Ambient Option

The low ambient option provides special control logic, oil coolers, and variable frequency drives on the condenser fan circuits to permit low temperature startup and operation down to 0°F (-18°C).

High Ambient Option

The high ambient option consists of special control logic and oil coolers to permit high ambient (up to 125°F [51°C]) operation. This option offers the best performance when coupled with the high efficiency performance option.

Remote Evaporator

The remote evaporator option is available on the RTAC 140-250 ton units. This option provides a pre-engineered method of installing the evaporator and all related components indoors. Remote evaporator installations allow the water loop to remain indoors to prevent freezing, thus eliminating the addition of glycol to the system and the resulting performance degradation. Please contact your Trane Sales Representative for split system design guidelines found in Engineering Bulletin RLC-PRB014-EN.

Electrical Options**Circuit Breaker**

A HACR rated molded case capacity circuit breaker (UL approved) is available. The circuit breaker can also be used to disconnect the chiller from main power with a through the door handle and comes pre-wired from the factory with terminal block power connections. The external operator handle is lockable.

Non-Fused Power Disconnect Switch

The non-fused molded case disconnect switch (UL approved) is used to disconnect the chiller from main power and comes pre-wired from the factory with terminal block power connections. The external operator handle is lockable.

Single/Dual Incoming Power Line Connection

Single or dual points of termination are available for incoming power line connections*. Units with 3-4 compressors must order circuit breakers with the single point connection option.*Some restrictions may apply.

Wye-Delta Compressor Start Type

This option provides a reduced inrush starter. Wye-Delta starters are standard on 200-230 volt machines.

Control Options**BACnet Communications Interface**

Allows the user to easily interface with BACnet via a single twisted pair wiring to a factory installed and tested communication board.

LonTalk (LCI-C) Communications Interface

Provides the LonMark chiller profile inputs/outputs for use with a generic building automation system.

Remote Input Options

Permits remote chilled liquid setpoint, remote current limit setpoint, or both by accepting a 4-20 mA or 2-10 Vdc analog signal.

Remote Output Options

Permits alarm relay outputs, ice making outputs, or both.

Tracer Summit Communication Interface

Permits bi-directional communication to the Tracer Summit system.

Other Options**Architectural Louvered Panels**

Louvered panels cover the complete condensing coil and service area beneath the condenser.

Coil Protection

Louvered panels protect the condenser coils only.

Compressor Sound Enhancement

Factory installed weatherproof compressor enclosure to reduce compressor sound levels.

Condenser Corrosion Protection

Copper fins and CompleteCoat are available on all size units for corrosion protection. Job site conditions should be matched with the appropriate condenser fin materials to inhibit coil corrosion and ensure extended equipment life. The CompleteCoat option provides fully assembled coils with a flexible dip and bake epoxy coating.

Convenience Outlet

Provides a 15 amp, 115 volt (60 Hz) convenience outlet on the unit.

Flange Kit

Provides a raised face flange kit that converts the grooved pipe evaporator water connections to flange connectors.

Insulation for High Humidity

The evaporator is covered with factory-installed 1.25 inch (31.8 mm) Armaflex II or equal (k=0.28) insulation. Foam insulation is used on the suction line.

Low Noise Fans

Complete fan assembly combining ultra quiet seven blade fans and TEAO fan motors to provide sound reductions with no performance degradation to the unit. The fan blades are heavy-duty molded plastic with wavy edges to reduce airflow turbulence.

Neoprene Isolators

Isolators provide isolation between chiller and structure to help eliminate vibration transmission. Neoprene isolators are more effective and recommended over spring isolators.

To Convert From:	To:	Multiply By:	To Convert From:	To:	Multiply By:
Length			Energy and Power and Capacity		
Feet (ft)	meters (m)	0.30481	British Thermal Units (BTUH)	Kilowatt (kW)	0.000293
Inches (In)	millimeters (mm)	25.4	British Thermal Units (BTU)	KCalorie (Kcal)	0.252
Area			Tons (refrig. effect)	Kilowatt (refrig. effect)	3.516
Square Feet (ft ²)	square meters (m ²)	0.093	Tons (refrig. effect)	Kilocalories per hour (Kcal/hr)	3024
Square Inches (In ²)	square millimeters (mm ²)	645.2	Horsepower	Kilowatt (kW)	0.7457
Volume			Pressure		
Cubic Feet (ft ³)	Cubic meters (m ³)	0.0283	Feet of water (ftH ₂ O)	Pascals (PA)	2990
Cubic Inches (In ³)	Cubic mm (mm ³)	16387	Inches of water (inH ₂ O)	Pascals (PA)	249
Gallons (gal)	litres (l)	3.785	Pounds per square inch (PSI)	Pascals (PA)	6895
Gallons (gal)	cubic meters (m ³)	0.003785	PSI	Bar or KG/CM ²	6.895 x 10 ⁻²
Flow			Weight		
Cubic feet/min (cfm)	cubic meters/second (m ³ /s)	0.000472	Ounces (oz)	Kilograms (kg)	0.02835
Cubic Feet/min (cfm)	cubic meters/hr (m ³ /hr)	1.69884	Pounds (lbs)	Kilograms (Kg)	0.4536
Gallons/minute (GPM)	cubic meters/hr (m ³ /hr)	0.2271	Fouling factors for heat exchangers		
Gallons/minute (GPM)	litres/second (l/s)	0.06308	0.00075 ft ² °F hr/BTU	= 0.132 m ² ° K/kW	
Velocity			0.00025 ft ² °F hr/BTU	= 0.044 m ² ° K/kW	
Feet per minute (ft/m)	meters per second (m/s)	0.00508			
Feet per second (ft/s)	meters per second (m/s)	0.3048			

Temperature – Centigrade (°C) Versus Fahrenheit (°F)

Note: The center columns of numbers, referred to as BASE TEMP, is the temperature in either degrees Fahrenheit (°F) or Centigrade (°C), whichever is desired to convert into the other. If degrees Centigrade is given, read degrees Fahrenheit to the right. If degrees Fahrenheit is given, read degrees Centigrade to the left.

Temperature			Temperature			Temperature			Temperature			Temperature		
°C	C or F	°F	°C	C or F	°F	°C	C or F	°F	°C	C or F	°F	°C	C or F	°F
-40.0	-40	-40.0	-15.0	+5	+41.0	+10.0	+50	+122.0	+35.0	+95	+203.0	+60.0	+140	+284.0
-39.4	-39	-38.2	-14.4	+6	+42.8	+10.6	+51	+123.8	+35.6	+96	+204.8	+60.6	+141	+285.8
-38.9	-38	-36.4	-13.9	+7	+44.6	+11.1	+52	+125.6	+36.1	+97	+206.6	+61.1	+142	+287.6
-38.3	-37	-34.6	-13.3	+8	+46.4	+11.7	+53	+127.4	+36.7	+98	+208.4	+61.7	+143	+289.4
-37.8	-36	-32.8	-12.8	+9	+48.2	+12.2	+54	+129.2	+37.2	+99	+210.2	+62.2	+144	+291.2
-37.2	-35	-31.0	-12.2	+10	+50.0	+12.8	+55	+131.0	+37.8	+100	+212.0	+62.8	+145	+293.0
-36.7	-34	-29.2	-11.7	+11	+51.8	+13.3	+56	+132.8	+38.3	+101	+213.8	+63.3	+146	+294.8
-36.1	-33	-27.4	-11.1	+12	+53.6	+13.9	+57	+134.6	+38.9	+102	+215.6	+63.9	+147	+296.6
-35.6	-32	-25.6	-10.6	+13	+55.4	+14.4	+58	+136.4	+39.4	+103	+217.4	+64.4	+148	+298.4
-35.0	-31	-23.8	-10.0	+14	+57.2	+15.0	+59	+138.2	+40.0	+104	+219.2	+65.0	+149	+300.2
-34.4	-30	-22.0	-9.4	+15	+59.0	+15.6	+60	+140.0	+40.6	+105	+221.0	+65.6	+150	+302.0
-33.9	-29	-20.2	-8.9	+16	+60.8	+16.1	+61	+141.8	+41.1	+106	+222.8	+66.1	+151	+303.8
-33.3	-28	-18.4	-8.3	+17	+62.6	+16.7	+62	+143.6	+41.7	+107	+224.6	+66.7	+152	+305.6
-32.8	-27	-16.6	-7.8	+18	+64.4	+17.2	+63	+145.4	+42.2	+108	+226.4	+67.2	+153	+307.4
-32.2	-26	-14.8	-7.2	+19	+66.2	+17.8	+64	+147.2	+42.8	+109	+228.2	+67.8	+154	+309.2
-31.7	-25	-13.0	-6.7	+20	+68.0	+18.3	+65	+149.0	+43.3	+110	+230.0	+68.3	+155	+311.0
-31.1	-24	-11.2	-6.1	+21	+69.8	+18.9	+66	+150.8	+43.9	+111	+231.8	+68.9	+156	+312.8
-30.6	-23	-9.4	-5.5	+22	+71.6	+19.4	+67	+152.6	+44.4	+112	+233.6	+69.4	+157	+314.6
-30.0	-22	-7.6	-5.0	+23	+73.4	+20.0	+68	+154.4	+45.0	+113	+235.4	+70.0	+158	+316.4
-29.4	-21	-5.8	-4.4	+24	+75.2	+20.6	+69	+156.2	+45.6	+114	+237.2	+70.6	+159	+318.2
-28.9	-20	-4.0	-3.9	+25	+77.0	+21.1	+70	+158.0	+46.1	+115	+239.0	+71.1	+160	+320.0
-28.3	-19	-2.2	-3.3	+26	+78.8	+21.7	+71	+159.8	+46.7	+116	+240.8	+71.7	+161	+321.8
-27.8	-18	-0.4	-2.8	+27	+80.6	+22.2	+72	+161.6	+47.2	+117	+242.6	+72.2	+162	+323.6
-27.2	-17	+1.4	-2.2	+28	+82.4	+22.8	+73	+163.4	+47.8	+118	+244.4	+72.8	+163	+325.4
-26.7	-16	+3.2	-1.7	+29	+84.2	+23.3	+74	+165.2	+48.3	+119	+246.2	+73.3	+164	+327.2
-26.1	-15	+5.0	-1.1	+30	+86.0	+23.9	+75	+167.0	+48.9	+120	+248.0	+73.9	+165	+329.0
-25.6	-14	+6.8	-0.6	+31	+87.8	+24.4	+76	+168.8	+49.4	+121	+249.8	+74.4	+166	+330.8
-25.0	-13	+8.6	0.0	+32	+89.6	+25.0	+77	+170.6	+50.0	+122	+251.6	+75.0	+167	+332.6
-24.4	-12	+10.4	+0.6	+33	+91.4	+25.6	+78	+172.4	+50.6	+123	+253.4	+75.6	+168	+334.4
-23.9	-11	+12.2	+1.1	+34	+93.2	+26.1	+79	+174.2	+51.1	+124	+255.2	+76.1	+169	+336.2
-23.3	-10	+14.0	+1.7	+35	+95.0	+26.7	+80	+176.0	+51.7	+125	+257.0	+76.7	+170	+338.0
-22.8	-9	+15.8	+2.2	+36	+96.8	+27.2	+81	+177.8	+52.2	+126	+258.8	+77.2	+171	+339.8
-22.2	-8	+17.6	+2.8	+37	+98.6	+27.8	+82	+179.6	+52.8	+127	+260.6	+77.8	+172	+341.6
-21.7	-7	+19.4	+3.3	+38	+100.4	+28.3	+83	+181.4	+53.3	+128	+262.4	+78.3	+173	+343.4
-21.1	-6	+21.2	+3.9	+39	+102.2	+28.9	+84	+183.2	+53.9	+129	+264.2	+78.9	+174	+345.2
-20.6	-5	+23.0	+4.4	+40	+104.0	+29.4	+85	+185.0	+54.4	+130	+266.0	+79.4	+175	+347.0
-20.0	-4	+24.8	+5.0	+41	+105.8	+30.0	+86	+186.8	+55.0	+131	+267.8	+80.0	+176	+348.8
-19.4	-3	+26.6	+5.5	+42	+107.6	+30.6	+87	+188.6	+55.6	+132	+269.6	+80.6	+177	+350.6
-18.9	-2	+28.4	+6.1	+43	+109.4	+31.1	+88	+190.4	+56.1	+133	+271.4	+81.1	+178	+352.4
-18.3	-1	+30.2	+6.7	+44	+111.2	+31.7	+89	+192.2	+56.7	+134	+273.2	+81.7	+179	+354.2
-17.8	0	+32.0	+7.2	+45	+113.0	+32.2	+90	+194.0	+57.2	+135	+275.0	+82.2	+180	+356.0
-17.2	+1	+33.8	+7.8	+46	+114.8	+32.8	+91	+195.8	+57.8	+136	+276.8	+82.8	+181	+357.8
-16.7	+2	+35.6	+8.3	+47	+116.6	+33.3	+92	+197.6	+58.3	+137	+278.6	+83.3	+182	+359.6
-16.1	+3	+37.4	+8.9	+48	+118.4	+33.9	+93	+199.4	+58.9	+138	+280.4	+83.9	+183	+361.4
-15.6	+4	+39.2	+9.4	+49	+120.2	+34.4	+94	+201.2	+59.4	+139	+282.2	+84.4	+184	+363.2

FOR INTERPOLATION IN THE ABOVE TABLE USE:

BASE TEMPERATURE (°F or °C)	1	2	3	4	5	6	7	8	9	10
DEGREES CENTIGRADE:	0.56	1.11	1.67	2.22	2.78	3.33	3.89	4.44	5.00	5.56
DEGREES FAHRENHEIT:	1.8	3.6	5.4	7.2	9.0	10.8	12.6	14.4	16.2	18.0



Trane optimizes the performance of homes and buildings around the world. A business of Ingersoll Rand, the leader in creating and sustaining safe, comfortable and energy efficient environments, Trane offers a broad portfolio of advanced controls and HVAC systems, comprehensive building services, and parts. For more information, visit www.Trane.com.

Trane has a policy of continuous product and product data improvement and reserves the right to change design and specifications without notice.

© 2012 Trane All rights reserved
RLC-PRC006-EN 25 May 2012
Supersedes RLC-PRC006-EN (01 Aug 2011)

We are committed to using environmentally
conscious print practices that reduce waste.

